

Electric Products

MCB / MC&TOR / MMS / MCCB /
ACB / FDB / SMDB / VCB



LS ELECTRIC

Electric Products

Customer satisfaction with world-class products and services
LS ELECTRIC is committed to excellence!



Miniature Circuit Breakers



Surge Protective Device



Vacuum Circuit Breakers



Air Circuit Breakers



Molded Case Circuit Breakers



Contactors & Overload Relays



Contents

Miniature Circuit Breakers	4
Residual Current Circuit Breakers	6
Surge Protective Device	8
Contactors & Overload Relays	16
Mini Contactors	26
Digital Motor Protection Relay	27
Manual Motor Starters	28
Molded Case Circuit Breakers	30
Earth Leakage Circuit Breakers	38
Air Circuit Breakers	42
LS Final Distribution Boards	52
LS SMDB Solution	56
Vacuum Circuit Breakers	60

Miniature Circuit Breakers

1, 2, 3 and 4pole series up to 125AF [IEC/EN 60898-1, IEC/EN 60947-2]

MCB, Switch- Disconnecter



Type	MCB(Miniature circuit breaker)				
	LA40E	LA40N	LA63E	LA63N	LA63H
Protection	Overload/short circuit	Overload/short circuit	Overload/short circuit	Overload/short circuit	Overload/short circuit
Standards	IEC/EN 60898-1	IEC/EN 60898-1	IEC/EN 60898-1	IEC/EN 60898-1/ 60947-2	IEC/EN 60898-1/ 60947-2
Rated voltage (Ue)	240VAC	240VAC	240/415VAC	240/415VAC, 70/125VDC	240/415VAC, 70/125VDC
Poles	1P+N	1P+N	1P, 1P+N, 2P, 3P, 3P+N, 4P	1P, 1P+N, 2P, 3P, 3P+N, 4P	1P, 1P+N, 2P, 3P, 3P+N, 4P
Rated current (In)	1, 2, 3, 4, 6, 10, 13, 16, 20, 25, 32, 40A	1, 2, 3, 4, 6, 10, 13, 16, 20, 25, 32, 40A	1, 2, 3, 4, 6, 10, 13, 16, 20, 25, 32, 40, 50, 63A	1, 2, 3, 4, 6, 10, 13, 16, 20, 25, 32, 40, 50, 63A	1, 2, 3, 4, 6, 10, 13, 16, 20, 25, 32, 40, 50, 63A
Breaking capacity	4.5kA	6kA	4.5kA	6kA	10kA
Isolation function	Yes	Yes	Yes	Yes	Yes
Tripping curve	B, C, D	B, C, D	B, C, D	B, C, D	B, C, D
Electrical durability	4000	4000	10000	10000	10000
Mechanical durability	10000	10000	20000	20000	20000
Terminal capacity	Cable up to 16mm ²	Cable up to 16mm ²	Cable up to 25mm ²	Cable up to 25mm ²	Cable up to 25mm ²
Accessory	-	-	AX, AL, SHT, U/OVT	AX, AL, SHT, U/OVT	AX, AL, SHT, U/OVT
Dimension					



	MCB(Miniature circuit breaker)					Switch-Disconnecter
	LA63L	LA100H	LA125H	LA63HP	LA63HDC	LA125D
	Overload/short circuit	Overload/short circuit	Overload/short circuit	Overload/short circuit	Overload/short circuit	-
	IEC/EN 60898-1/ 60947-2	IEC/EN 60947-2	IEC/EN 60947-2	IEC/EN 60947-2	IEC/EN 60947-2	IEC/EN 60947-3
	240/415VAC, 70/125VDC	240/415VAC	240/415VAC	240/415VAC	250/500/750/1000VDC	240/415VAC
	1P, 1P+N, 2P, 3P, 3P+N, 4P	1P, 2P, 3P, 4P	1P, 2P, 3P, 4P	1P, 2P, 3P, 4P	1P, 2P, 3P, 4P	1P, 2P, 3P, 4P
	1, 2, 3, 4, 6, 10, 13, 16, 20, 25, 32, 40, 50, 63A	63, 80, 100A	10, 16, 20, 25, 32, 40, 50, 63, 80, 100, 125A	6, 10, 13, 16, 20, 25, 32, 40, 50, 63A	1, 2, 3, 4, 6, 10, 13, 16, 20, 25, 32, 40, 50, 63A	40, 50, 63, 80, 100, 125A
	AC 1~4A : 70kA AC 6~32A : 25kA AC 40~63A : 15kA DC 1~63A : 15kA	10kA	10~63A : 20kA 80~125A : 10kA	10kA	10kA	-
	Yes	Yes	Yes	Yes	Yes	Yes
	B, C, D	C(8In), D(12In)	C(8In), D(12In)	B(4In), C(8In)	C(6In), D(12In)	-
	10000	1500	1500	4000	1500	1500(125A 1000)
	20000	10000	10000	10000	20000	10000
	Cable up to 25mm ²	Cable up to 50mm ²	Cable up to 50mm ²	Cable up to 25mm ²	Cable up to 25mm ²	Cable up to 50mm ²
	AX, AL, SHT, U/OVT	AX, AL, SHT, U/OVT	AX, AL, SHT, U/OVT	-	AX, AL, SHT	AX

Residual Current Circuit Breakers

2 and 4 pole series up to 100AF

RCBO, RCCB



Type	RCBO(Residual Current Breaker with Overcurrent protection)				
	LB40NN	LB40N	LB40H	LB40NB	LB63N
Protection	Leakage current/ Overload/Short circuit	Leakage current/ Overload/Short circuit	Leakage current/ Overload/Short circuit	Leakage current/ Overload/Short circuit	Leakage current/ Overload/Short circuit
Standards	IEC/EN 61009-1	IEC/EN 61009-1	IEC/EN 61009-1	IEC/EN 61009-1, 62423	IEC/EN 61009-1
Operation type	AC, A	AC, A	AC, A	B	AC, A
Rated voltage (Ue)	240VAC	240/415VAC	240/415VAC	240/415VAC	240VAC
Poles	1P+N	1P+N, 3P+N	1P+N, 3P+N	1P+N, 3P+N	1P+N
Rated current (In)	6, 10, 13, 16, 20, 25, 32, 40A	6, 10, 13, 16, 20, 25, 32, 40A	6, 10, 13, 16, 20, 25, 32, 40A	6, 10, 13, 16, 20, 25, 32, 40A	6, 10, 13, 16, 20, 25, 32, 40, 50, 63A
Breaking capacity	6kA	6kA	10kA	6kA	6kA
Isolation function	Yes	Yes	Yes	Yes	Yes
Tripping curve	B, C	B, C, D	B, C, D	B, C, D	B, C, D
Sensitivity, mA	10, 30, 100, 300	30, 100, 300	30, 100, 300	30, 100, 300	30, 50, 100, 300
Terminal capacity	Cable up to 16mm ²	Cable up to 16mm ²	Cable up to 16mm ²	Cable up to 16mm ²	Cable up to 25mm ²
Accessory	-	AX, AL, SHT, U/OVT	AX, AL, SHT, U/OVT	AX, AL, SHT, U/OVT	AX, AL, SHT, U/OVT
Dimension					

* LC63N's neutral is on the left of RCCB and LC63NR's neutral is on the right of RCCB
 * LC100H's neutral is on the left of RCCB and LC100HR's neutral is on the right of RCCB
 ** AC(S), A(S) is Earth-leakage protection time delayed product
 *** LB40NB 3P+N's width



RCBO(Residual Current Breaker with Overcurrent protection)				RCCB(Residual Current Circuit Breaker)		
LB63H	LB63H4	LB50HW	LB63HW	LC63N/LC63NR*	LC100H/LC100HR*	LC80HB
Leakage current/ Overload/Short circuit	Leakage current/ Overload/Short circuit	Leakage current/ Overload/Short circuit	Leakage current/ Overload/Short circuit	Leakage current	Leakage current	Leakage current
IEC/EN 61009-1	IEC/EN 61009-1	IEC/EN 61009-1	IEC/EN 61009-1	IEC/EN 61008-1	IEC/EN 61008-1	IEC/EN 61008-1, 62423
AC, A	AC, A	AC, A	AC, A	AC, A	AC, A, AC(S)**, A(S)**	B
240VAC	415VAC	230/240VAC	400/415VAC	240/415VAC	240/415VAC	240/415VAC
2P	4P	1P+N	3P+N	1P+N, 3P+N	1P+N, 3P+N	1P+N, 3P+N
6, 10, 13, 16, 20, 25, 32, 40, 50, 63A	6, 10, 13, 16, 20, 25, 32, 40, 50, 63A	6, 10, 13, 16, 20, 25, 32, 40, 50A	6, 10, 13, 16, 20, 25, 32, 40, 50, 63A	16, 25, 32, 40, 50, 63A	16, 25, 32, 40, 50, 63, 80, 100A	16, 25, 32, 40, 50, 63, 80A
10kA	10kA	10kA	10kA	-	-	-
Yes	Yes	Yes	Yes	Yes	Yes	Yes
B, C, D	B, C, D	B, C, D	B, C, D	-	-	-
30, 50, 100, 300	30, 50, 100, 300	10, 30, 100, 300	10, 30, 100, 300	30, 100, 300	30, 100, 300	30, 100, 300
Cable up to 25mm ²	Cable up to 25mm ²	Cable up to 25mm ²	Cable up to 25mm ²	Cable up to 25mm ²	Cable up to 50mm ²	Cable up to 50mm ²
-	-	-	-	AX, AL, SHT, U/OVT	AX, AL, SHT, U/OVT	AX, AL, SHT, U/OVT

Surge Protective Device

BK Series (Din-rail type)

Product description

The BK Series AC/DIN type surge protect a 50/60Hz electric system from surge voltages. Also, the system allows replacement of the protective element (MOV), ensuring convenience and economy. However, as only the protective module is provided, other components should be added when the system is installed in accordance with the site condition. When the protective device is activated (in an anomaly or an accident), the red lever in the status indicator protrudes.



Product rating <Uc: 385V>

Item		AC Type					
		BK05S-T3	BK10S-T2	BK20S-T2	BK30S-T2	BK40S-T2	BK12S-T1 ^{Note4)}
No. of poles	[Pole]	2, 4P	1, 1+N, 2, 3, 3+N, 4P				
Rated voltages	Un [V]	230/440V					
Max. continued-operation voltage	Uc [V]	-	385	385	385	385	385
	N-PE	-		255	255	255	255
Voltage protection level	Up [kV]	-	≤0.8	≤1.5	≤1.8	≤2.0	≤2.5
		N-PE	-	≤1.0	≤1.2	≤1.5	≤2.0
	Up [kV] [⊗]	-	≤2.0	≤1.5	≤1.8	-	≤2.5
		N-PE	-	≤2.5	≤2.5	-	≤3.5
Nominal discharge current	In [kA]	-	10	20	30	40	-
Max. discharge current	I _{max} [kA]	-	20	40	60	80	-
Impulse current	I _{imp} [kA]	-	-	-	-	-	12.5 (10/350)
Open circuit voltage	Uoc [kV]	10	-	-	-	-	-
Grades	Test class	Class III	Class II				Class I (Built-in type)
Reaction time		< 25ns					
Status indication ^{Note2)}		Have Status indication					
Operating temperature range		-40°C~80°C					
Cross-sectional area of the connecting wires		6~16mm ²	6~32mm ²				16~32mm ²
Accessories		AL ^{Note3)}					-
Standard		IEC 61643-11 / KS C IEC 61643-11 / UL1449					
Certification		CE, UL, KS, S	CE, UL, KS, S	CE, UL, KS, S	CE, UL	CE, UL, KS, S	CE

Note)

- When the protective device is activated (in an anomaly or an accident) in products with Class II and III indication features, the red lever in the status indicator protrudes.
- With a product with Class I indication feature, a green light will turn on when the protective device is in a normal condition. The green light will go off when the protective device is activated (for an anomaly or an accident).
- The AL contact accessories are not sold separately. You need to choose these accessories when you place your order for the product. Please be mindful of this fact when you place your order.
- The Class I products are integrated with the MOVs, which cannot be detached.

Product description

The BK Series AC / DIN type surge protect a 50/60Hz electric system from surge voltages. Also, the system allows replacement of the protective element (MOV), ensuring convenience and economy. However, as only the protective module is provided, other components should be added when the system is installed in accordance with the site condition. When the protective device is activated (in an anomaly or an accident), the red lever in the status indicator protrudes.



Product rating <Uc: 460V>

Item		AC Type				
		BK10S-T2	BK20S-T2	BK30S-T2	BK40S-T2	
No. of poles	[Pole]	1, 1+N, 2, 3, 3+N, 4P				
Rated voltages	Un [V]	254/440V				
Max. continued-operation voltage	Uc [V]	-	460	460	460	460
		N-PE	255	255	255	255
Voltage protection level	Up [kV]	-	≤1.5	≤2.0	≤2.2	≤2.5
		N-PE	≤1.0	≤1.2	≤1.5	≤2.0
	Up [kV] Ⓢ	-	-	-	-	-
		N-PE	-	-	-	-
Nominal discharge current	In [kA]	10	20	30	40	
Max. discharge current	I _{max} [kA]	20	40	60	80	
Impulse current	I _{imp} [kA]	-	-	-	-	
Open circuit voltage	Uoc [kV]	-	-	-	-	
Grades	Test class	Class II				
Reaction time		< 25ns				
Status indication <small>Note2)</small>		Have Status indication				
Operating temperature range		-40°C~80°C				
Cross-sectional area of the connecting wires		6~32mm ²				
Accessories		AL <small>Note3)</small>				
Standard		IEC 61643-11, UL1449				
Certification		CE, S	CE, S, UL	CE, S, UL	CE, S, UL	

Note)

- When the protective device is activated (in an anomaly or an accident) in products with Class II and III indication features, the red lever in the status indicator protrudes.
- With a product with Class I indication feature, a green light will turn on when the protective device is in a normal condition. The green light will go off when the protective device is activated (for an anomaly or an accident.)
- The AL contact accessories are not sold separately. You need to choose these accessories when you place your order for the product. Please be mindful of this fact when you place your order.

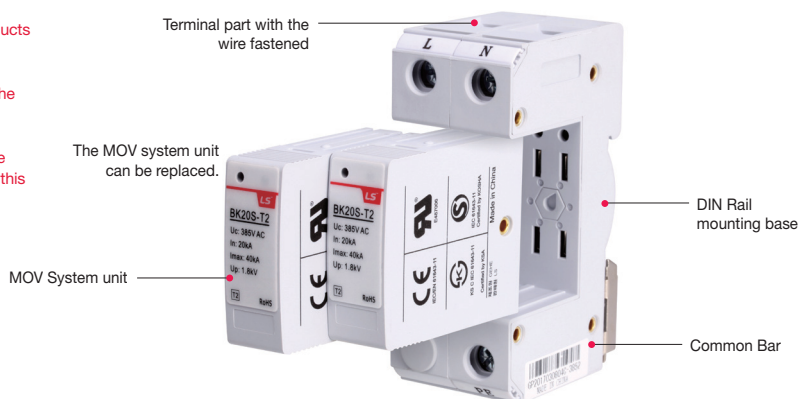

Surge Protective Device

BK Series (DC Din-rail type)

Product description

The BK Series DC/DIN type surge protect a DC electric system from surge voltages. Also, the system allows replacement of the protective element (MOV), ensuring convenience and economy. However, as only the protective module is provided, other components should be added when the system is installed in accordance with the site condition. When the protective device is in a normal condition, the indication display will be green. The display will turn black when the protective device is activated (for an anomaly or an accident.)



Product rating

Item		DC Type			
		BK20S-DC110	BK20S-DC600	BK20S-DC1000	BK20S-DC1500
No. of poles	[Pole]	2P		3P	
Rated voltages	Un [V]	DC110	DC600	DC1000	DC1500
Max. continued-operation voltage	Uc [V]	DC220	DC700	DC1200	DC1500
Voltage protection level	Up [kV]	≤1.0	≤2.5	≤3.9	≤4.5
Nominal discharge current	In [kA]	20	20	20	20
Max. discharge current	Imax [kA]	40	40	40	40
Impulse current	Iimp [kA]	-	-	-	-
Grades	Test Class	Class II			
Reaction time		< 25ns			
Status indication		Have Status indication			
Operating temperature range		-40°C~80°C			
Cross-sectional area of the connecting wires		6mm ² or more			
Accessories		AL ^{Note1)}			
Standard		IEC 61643-11 / UL1449			
Certification		CE	CE, UL	CE, UL	CE
SPD Disconnector	MCCB	TD100 2P 32A	TD100 3P 32A	TD100 4P 32A	TSD250N/H 4P 63A
	MCB	BK63H-DC 2P 40A	BK63H-DC 3P 40A	BK63H-DC 4P 40A	-

Note) 1. The AL contact accessories are not sold separately.
 You need to choose these accessories when you place your order for the product.
 Please be mindful of this fact when you place your order.



SD Series (SPD Disconnecter)

Product description

SPD Disconnecter is a device that separates the SPD from the system during SPD failure and maintenance work. It has a trip function that can detect and cut off leakage current caused by SPD deterioration (varistor burnout, etc.) and has a high surge resistance to prevent the unintended trip operation of the Disconnecter.



Product rating

Item		SD10-T2	SD20-T2	SD30-T2	SD40-T2	SD13-T1
No. of poles		1, 2, 3, 4P				
Rated voltages	Ue [V]	230/400				
Rated insulation voltage	Ui [V]	500				
Voltage protection level	Up [kV]	0.25	0.4	0.5	0.7	0.3
Nominal discharge current	In [kA]	10	20	30	40	-
Max. discharge current	I _{max} [kA]	20	40	60	80	-
Impulse current	I _{imp} [kA]	-	-	-	-	12.5kA
Grades	Test Class	Class II, III		Class II		Class I
Short circuit current	I _{sc} [kA]	25				
Frequency	[Hz]	50/60				
Min. delay current	I _t	3A (<10s)				
Min. instantaneous current	I _i	5A (>0.1s), 10A(<0.1s)				
Protection degree		IP20				
Max. connection wire range		25mm ²				
AL connection wire range		1.5mm ²				
Operating temperature range		-25°C~60°C				
Ambient humidity		20%~90%				
Din-Rail		EN60715 (35mm)				

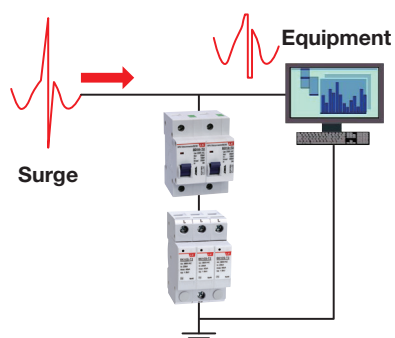

- Convenient SPD replacement
- High surge resistance
- Leakage current detection
- Prevent malfunctions in case of short circuit
- Easy installation using DIN rail

* AL available for SD20-T2 and SD-40T2

Surge Protective Device

SP Series (Box type)

Product description

The SP series surge protective device is applied to the alternating current 50/60Hz, 220V/380V power system and provides the protection from the surge overvoltage of an electric system. Moreover, the protection module, disconnectable device (fuse), and fastened power and ground wires are organized into the all-in-one steel cabinet with convenient installation and stability.

If the protective device is normal, the display becomes green. The display becomes red after operation (abnormal or after an accident).



Product rating

- Single phase 2W+G (SPL)

SPD Type	SPL (AC 110/220V)		SPL (AC 220V)	
	SPL3-20S		SPL2-40S	SPL2-80S
Class	Class III		Class II	
Rated system [Pole]	2W+G		2W+G	
Rated voltage, Un AC [V]	110, 220		220	
Max. continuous operating voltage, Uc AC [V]	275		385	
Voltage protection level, Up [kV]	1.5	2.5	3.0	
Operation voltage, Uoc [kV/kA]	20/10	-	-	
Nominal discharge current, In (8/20 μ s) [kA, per mode]	-	20	40	
Maximum discharge current, I _{max} (8/20 μ s) [kA, per mode]	-	40	80	
Response time, tA [ns]	< 5 ns		< 5 ns	
Operating temperature range [°C]	-40 ~ +70°C		-40 ~ +70°C	
Operating frequency [Hz]	50/60 Hz		50/60 Hz	
Mounting on	Screw		Screw	
Operation status indication	Normal operation: Green, Abnormal/After an accident: Red			
Protection degree	IP20		IP20	
Protection mode	L-N, N-PE (G), L-PE (G)		L-N, N-PE (G)	
Ground	TN		TN	
Certification	CE		KS, CE	



Product rating

- Three phase 3W+G (SPT) AC 220V

SPD Type	SPT (AC 220V)			
	SPT2-40S	SPT2-80S	SPT1-120S	SPT1-160S
Class	Class II		Class I, Class II	
Rated system [Pole]	3W+G			
Rated voltage, Un AC [V]	220			
Max. continuous operating voltage, Uc AC [V]	385			
Voltage protection level, Up [kV]	2.5	3.0	2.0	2.0
Nominal discharge current, In (8/20 μ s) [kA, per mode]	20	40	-	-
Maximum discharge current, I _{max} (8/20 μ s) [kA, per mode]	40	80	120	160
Lightning impulse current, I _{imp} (10/350 μ s) [kA, per mode]	-	-	6.5	6.5
Response time, tA [ns]	< 5 ns			
Operating temperature range [°C]	-40 ~ +70°C			
Operating frequency [Hz]	50/60 Hz			
Mounting on	Screw			
Operation status indication	Normal operation: Green, Abnormal/After an accident: Red			
Protection degree	IP20			
Protection mode	L-PE (G)			
Ground	TN			
Certification	KS, CE			

* SPT can not be used in Delta wiring grounding system

Product rating

- Three phase 3W+G (SPT) AC 380V



SPD Type	SPT (AC 380V)			
	SPT2-40S	SPT2-80S	SPT1-120S	SPT1-160S
Class	Class II		Class I, Class II	
Rated system [Pole]	3W+G			
Rated voltage, U_n [V]	AC 380			
Max. continuous operating voltage, U_c [V]	AC 385			
Voltage protection level, U_p [kV]	2.5	3.0	2.0	2.0
Nominal discharge current, I_n (8/20 μ s) [kA, per mode]	20	40	-	-
Maximum discharge current, I_{max} (8/20 μ s) [kA, per mode]	40	80	120	160
Lightning impulse current, I_{imp} (10/350 μ s) [kA, per mode]	-	-	6.5	6.5
Response time, t_A [ns]	< 5 ns			
Operating temperature range [°C]	-40 ~ +70°C			
Operating frequency [Hz]	50/60 Hz			
Mounting on	Screw			
Operation status indication	Normal operation: Green, Abnormal/After an accident: Red			
Protection degree	IP20			
Protection mode	L-PE (G)			
Ground	TN			
Certification	KS, CE			

* SPT can not be used in Delta wiring grounding system

Product rating

- Three phase 3W+G (SPT) AC 440V



SPD Type	SPT (AC 440V)			
	SPT2-40S	SPT2-80S	SPT1-120S	SPT1-160S
Class	Class II		Class I, Class II	
Rated system [Pole]	3W+G			
Rated voltage, U_n [V]	AC 440			
Max. continuous operating voltage, U_c [V]	AC 385			
Voltage protection level, U_p [kV]	2.5	3.0	2.0	2.0
Nominal discharge current, I_n (8/20 μ s) [kA, per mode]	20	40	-	-
Maximum discharge current, I_{max} (8/20 μ s) [kA, per mode]	40	80	120	160
Lightning impulse current, I_{imp} (10/350 μ s) [kA, per mode]	-	-	6.5	6.5
Response time, t_A [ns]	< 5 ns			
Operating temperature range [°C]	-40 ~ +70°C			
Operating frequency [Hz]	50/60 Hz			
Mounting on	Screw			
Operation status indication	Normal operation: Green, Abnormal/After an accident: Red			
Protection degree	IP20			
Protection mode	L-PE (G)			
Ground	TN			
Certification	KS, CE			

* SPT can not be used in Delta wiring grounding system

Surge Protective Device

SP Series (Box type)

Product rating

- Three phase 4W +G (SPY) 127S



SPD Type	SPY (AC 127/220V)				
	SPY2-40S	SPY2-80S	SPY1-120S	SPY1-160S	SPY1-200S *
Class	Class II		Class I, Class II		
Rated system [Pole]	4W+G				
Rated voltage, Un AC [V]	127/220				
Max. continuous operating voltage, Uc AC [V]	385				
Voltage protection level, Up [kV]	2.5	3.0	2.0	2.0	2.0
Nominal discharge current, In (8/20 μ s) [kA, per mode]	20	40	-	-	-
Maximum discharge current, I _{max} (8/20 μ s) [kA, per mode]	40	80	120	160	200
Lightning impulse current, I _{imp} (10/350 μ s) [kA, per mode]	-	-	6.5	6.5	12.5
Response time, tA [ns]	< 5 ns				
Operating temperature range [°C]	-40 ~ +70°C				
Operating frequency [Hz]	50/60 Hz				
Mounting on	Screw				
Operation status indication	Normal operation: Green, Abnormal/After an accident: Red				
Protection degree	IP20				
Protection mode	L-N, N-PE (G)				
Ground	TN				
Certification	KS, CE				

* The wiring direction of SPY1-200S is located on the side. (Refer to external dimension)

Product rating

- Three phase 4W+G (SPY) 220S



SPD Type	SPY (AC 220/380V)				
	SPY2-40S	SPY2-80S	SPY1-120S	SPY1-160S	SPY1-200S *
Class	Class II		Class I, Class II		
Rated system [Pole]	4W+G				
Rated voltage, Un AC [V]	220/380				
Max. continuous operating voltage, Uc AC [V]	385				
Voltage protection level, Up [kV]	2.5	3.0	2.0	2.0	2.0
Nominal discharge current, In (8/20 μ s) [kA, per mode]	20	40	-	-	-
Maximum discharge current, I _{max} (8/20 μ s) [kA, per mode]	40	80	120	160	200
Lightning impulse current, I _{imp} (10/350 μ s) [kA, per mode]	-	-	6.5	6.5	12.5
Response time, tA [ns]	< 5 ns				
Operating temperature range [°C]	-40 ~ +70°C				
Operating frequency [Hz]	50/60 Hz				
Mounting on	Screw				
Operation status indication	Normal operation: Green, Abnormal/After an accident: Red				
Protection degree	IP20				
Protection mode	L-N, N-PE (G)				
Ground	TN				
Certification	KS, CE				

* The wiring direction of SPY1-200S is located on the side. (Refer to external dimension)

Product rating - Iimp 12.5kA Class I SPD



SPD Type	SPL1-13/50S	SPT1-13S	SPY1-13/50S
Class	Class I		
Rated system [Pole]	2W+G	3W+G	4W+G
Rated voltage, Un AC [V]	220	380	380/220
Max. continuous operating voltage, Uc AC [V]	320		
Voltage protection level, Up [kV]	L-N : 1.2, N-PE : 1.8	L-N : 1.2, N-PE : 1.8	L-N : 1.2, N-PE : 1.8
Nominal discharge current, In (8/20 μ s) [kA, per mode]	-	-	-
Maximum discharge current, I _{max} (8/20 μ s) [kA, per mode]	-	-	-
Lightning impulse current, Iimp (10/350 μ s) [kA, per mode]	12.5/50	12.5	12.5/50
Response time, tA [ns]	< 5 ns		
Operating temperature range [°C]	-40 ~ +70°C		
Operating frequency [Hz]	50/60 Hz		
Mounting on	Screw		
Operation status indication	Normal operation: Green, Abnormal/After an accident: Red		
Protection degree	IP20		
Protection mode	L-N, N-PE (G)	L-PE (G)	L-N, N-PE (G)
Ground	TN/TT/IT		
Certification	KS, CE		

* SPT can not be used in Delta wiring grounding system

Product rating - Iimp 25kA Class I SPD



SPD Type	SPL1-25/50S	SPT1-25S	SPY1-25/100S
Class	Class I		
Rated system [Pole]	2W+G	3W+G	4W+G
Rated voltage, Un AC [V]	220	380	380/220
Max. continuous operating voltage, Uc AC [V]	320		
Voltage protection level, Up [kV]	L-N : 1.3, N-PE : 2.0	L-N : 1.3, N-PE : 2.0	L-N : 1.3, N-PE : 2.0
Nominal discharge current, In (8/20 μ s) [kA, per mode]	-	-	-
Maximum discharge current, I _{max} (8/20 μ s) [kA, per mode]	-	-	-
Lightning impulse current, Iimp (10/350 μ s) [kA, per mode]	25/50	25	25/100
Response time, tA [ns]	< 5 ns		
Operating temperature range [°C]	-40 ~ +70°C		
Operating frequency [Hz]	50/60 Hz		
Mounting on	Screw		
Operation status indication	Normal operation: Green, Abnormal/After an accident: Red		
Protection degree	IP20		
Protection mode	N-PE (G)	L-PE (G)	L-N, N-PE (G)
Ground	TN/TT/IT		
Certification	KS, CE		

* SPT can not be used in Delta wiring grounding system

Contactors & Overload relays

Metasol MC 3P 18 to 150A

MC type Magnetic Contactors



Frame size			18AF				22AF			
Type	Screws clamp terminals		MC-6a	MC-9a	MC-12a	MC-18a	MC-9b	MC-12b	MC-18b	MC-22b
	Lug clamp terminals		-	-	-	-	-	-	-	-
Number of poles			3pole				3pole			
Rated operational voltage, Ue			690V				690V			
Rated insulation voltage, Ui			690V				690V			
Rated frequency			50/60Hz				50/60Hz			
Rated impulse withstand voltage, Uimp			6kV				6kV			
Maximum operating rate in operating cycles per hour(AC3)			1800 operations per hour				1800 operations per hour			
Durability	Mechanical		15 mil. operations				15 mil. operations			
	Electrical		2.5 mil. operations				2.5 mil. operations			
Current and power	AC-1, Thermal current	[A]	25	25	25	32	25	27	40	45
	AC-3 200/240V	[kW]	2.2	2.5	3.5	4.5	2.5	3.5	4.5	5.5
		[A]	9	11	13	18	11	13	18	22
	380/440V	[kW]	3	4	5.5	7.5	4	5.5	7.5	11
		[A]	7	9	12	18	9	12	18	22
	500/550V	[kW]	3	4	7.5	7.5	4	7.5	7.5	15
		[A]	6	7	12	13	7	12	13	20
	690V	[kW]	3	4	7.5	7.5	4	7.5	7.5	15
		[A]	4	5	9	9	6	9	9	18
	1000V	[kW]	-	-	-	-	-	-	-	-
[A]		-	-	-	-	-	-	-	-	
Rated Short-time withstand current (IEC 60947)	1s	[A]	210	250	280	300	250	280	300	400
	10s	[A]	105	110	120	130	110	120	154	186
	30s	[A]	70	70	80	85	70	80	100	130
	1min	[A]	61	61	61	70	61	61	84	90
	10min	[A]	40	45	47	50	45	50	60	60
	30min	[A]	30	30	30	40	30	30	40	50
UL rating (50/60Hz)	Continuous curren	[A]	25	25	25	32	25	25	40	40
	Single phase 110-120V	[HP]	0.5	0.5	1	2	0.5	1	2	2
		[HP]	1.5	1.5	2	3	1.5	2	3	3
	Three phase 200-208V	[HP]	2	2	3	7.5	2	3	7.5	7.5
		[HP]	3	3	5	7.5	3	5	7.5	10
	440-480V	[HP]	5	5	7.5	10	5	7.5	10	15
[HP]		7.5	7.5	10	15	7.5	10	15	20	
NEMA size			00	00	0	1	00	0	1	-
Size and weight	AC control	Weight	0,33				0,34			
		Size(W×H×D)	45×73.5×80.4				45×73.5×87.4			
	DC control	Weight	0,4				0,41			
		Size(W×H×D)	45×73.5×96.6				45×73.5×103.6			
Auxiliary(standard)			1NO or 1NC				1NO1NC			
Auxiliary	Side mount		UA-1				UA-1			
	Front mount		UA-2, UA-4				UA-2, UA-4			

Note) Minimum conduct current of Auxiliary contactor is DC 17V 5mA.

MT type Thermal Overload Relays



Type			MT-12/□	MT-32/□
Type	Screws clamp terminals		●	●
	Lug clamp terminals		-	-
Rated operational voltage, Ue			690	690
Rated insulation voltage, Ui			690	690
Rated impulse withstand voltage, Uimp			6	6
Trip class			10A, 20	10A, 20
Setting range			0.1~18A	0.1~40A
Size and weight	Weight	kg	0.1	0.17
		Size(W×H×D)	45×73.2×63.7	45×75×90

* The safety cover of magnetic contactor and thermal overload relay is optional.



40AF		65AF		100AF			150AF	
MC-32a	MC-40a	MC-50a	MC-65a	MC-75a	MC-85a	MC-100a	MC-130a	MC-150a
●	●	●	●	●	●	●	●	●
-	-	●	●	●	●	●	●	●
3pole		3pole		3pole			3pole	
1000V		1000V		1000V			1000V	
1000V		1000V		1000V			1000V	
50/60Hz		50/60Hz		50/60Hz			50/60Hz	
8kV		8kV		8kV			8kV	
1800 operations per hour		1800 operations per hour		1800 operations per hour			1200 operations per hour	
12 mil. operations		12 mil. operations		12 mil. operations			5 mil. operations	
2 mil. operations		2 mil. operations		2 mil. operations		1 mil. operations	1 mil. operations	
55	60	100	115	125	135	160	200	250
7.5	11	15	18.5	22	25	30	37	45
32	40	55	65	75	85	105	130	150
15	18.5	22	30	37	45	55	60	75
32	40	50	65	75	85	105	130	150
18.5	22	30	33	37	45	55	60	70
28	32	43	60	64	75	85	90	100
18.5	22	30	33	37	45	55	55	55
20	23	28	35	42	45	65	60	60
22	22	30	30	37	37	37	75	75
17	17	23	23	28	28	28	50	50
600	700	1000	1050	1100	1200	1320	1350	1800
260	300	550	700	750	800	900	950	1200
160	190	330	380	400	450	500	700	800
100	120	250	270	300	350	400	550	600
70	80	150	200	220	270	270	350	450
55	65	90	120	140	170	180	200	300
50	60	87	96	114	150	160	175	280
50	60	70	100	110	135	160	200	250
3	3	3	5	5	7.5	10	10	15
5	7.5	10	15	15	15	20	20	25
7.5	15	20	25	25	30	30	40	40
10	15	25	30	30	40	40	40	50
20	30	40	50	50	60	75	75	100
25	30	50	60	60	75	75	75	75
1P	2	-	-	-	3	-	-	4
0.55		1.05		1.93			2.4	
69×83×90		79×106×119		94×140×135.8				
0.77		1.3		2.8			119×158×130.3	
69×83×117.1		79×106×146.4		94×140×172.3				
2NO2NC		2NO2NC		2NO2NC			2NO2NC	
UA-1		UA-1		UA-1			UA-1	
UA-2, UA-4		UA-2, UA-4		UA-2, UA-4			UA-2, UA-4	



MT-32/□	MT-63/□	MT-95/□	MT-150/□
●	●	●	●
-	●	●	●
690	690	690	690
690	690	690	690
6	6	6	6
10A, 20	10A, 20	10A, 20	10A, 20
0.1~40A	4~65A	7~100A	34~150A
0.17	0.31/0.33	0.48/0.5	0.67
45×75×90	55×81×100	70×97×110	95×109×113

Contactors & Overload relays

Metasol MC 3P 225 to 2100A

MC type Magnetic Contactors



Frame size		225AF			400AF		
Type	Screws clamp terminals		MC-185a	MC-225a	MC-265a	MC-330a	MC-400a
Number of poles			3		3		
Rated operational voltage, Ue			1000		1000		
Rated insulation voltage, Ui			1000		1000		
Rated frequency			50/60		50/60		
Rated impulse withstand voltage, Uimp			8		8		
Maximum operating rate in operating cycles per hour(AC3)			1200		1200		
Durability	Mechanical		500		500		250
	Electrical		100		100		50
Current and power	AC-1, Thermal current [A]		300	350	400	500	520
	AC-3	200/240V [kW]	55	75	80	90	125
		[A]	185	225	265	330	400
	380/440V	[kW]	90	132	147	160	200
		[A]	185	225	265	330	400
	500/550V	[kW]	110	132	147	160	225
		[A]	180	200	225	280	350
	690V	[kW]	110	140	160	200	250
		[A]	120	150	185	220	300
	1000V	[kW]	132	132	147	147	147
[A]		90	90	105	105	105	
Rated Short-time withstand current (IEC 60947)	1s [A]	2000	2500	3500	4000	4600	
	10s [A]	1500	1700	2400	3000	4400	
	30s [A]	1000	1200	1500	2500	2974	
	1min [A]	800	1000	1100	1700	1846	
	10min [A]	520	700	800	1000	1313	
	30min [A]	350	500	600	620	760	
	≥15min [A]	320	400	500	553	699	
UL rating (50/60Hz)	Continuous curren [A]		300	350	400	500	520
	Single phase	110-120V [HP]	15	15	-	-	-
		220-240V [HP]	30	40	-	-	-
	Three phase	200-208V [HP]	60	60	75	100	125
		220-240V [HP]	60	75	100	100	150
	440-480V [HP]	125	150	200	200	300	
550-600V [HP]	125	150	200	200	300		
NEMA size		-		5		-	
Size and weight	AC control	Weight [kg]	5.4		9.2		
	DC control	Size(W×H×D) [mm]	138×203×185.1		163×243×204.4		
Auxiliary(standard)	2NO2NC		2NO2NC		2NO2NC		
	Auxiliary	Side mount	AU-100, AU-100E (Max.4NO4NC)		AU-100, AU-100E (Max.4NO4NC)		
	Front mount		-		-		

MT type Thermal Overload Relays

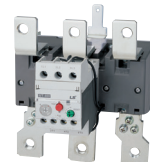

Type	MT-225/□		MT-400/□	
	●		●	
Rated operational voltage, Ue [V]	690		690	
Rated insulation voltage, Ui [V]	690		690	
Rated impulse withstand voltage, Uimp [kV]	6		6	
Trip class	10A, 20		10A, 20	
Setting range	65~240A		85~400A	
Size and weight	Weight [kg]	2.5	2.6	
	Size(W×H×D) [mm]	147×141×184	151×171×198	

* The safety cover of magnetic contactor and thermal overload relay is optional.



800AF			1260AF	2650AF			
MC-500a	MC-630a	MC-800a	MC-1260a	MC-1400a	MC-1700a	MC-2100a	MC-2650a
●	●	●	●	●	●	●	●
	3		3			3	
	1000		1000			1000	
	1000		1000			1000	
	50/60		50/60			50/60	
	8		8			8kV	
	1200		300			300	
	250		50		50		30
	50		5		5		2
700	900	1050	1260	1400	1700	2100	2650
147	190	220	-	290	310	-	-
500	630	800	-	860	1050	-	-
265	330	440	-	550	700	900	-
500	630	800	-	860	1050	1450	-
265	330	500	-	-	-	-	-
400	500	720	-	-	-	-	-
300	400	500	-	800	1000	-	-
380	420	630	-	800	950	-	-
280	280	280	-	-	-	-	-
220	220	220	-	-	-	-	-
6000	7000	7500	8000	-	-	-	-
5050	6400	7000	7200	8000	10000	10000	10000
4400	4500	4900	5200	-	-	-	-
3400	3500	3800	4000	4500	5500	5500	5500
2000	2200	2500	2300	-	-	-	-
1400	1550	1550	3000	2600	3000	3000	3000
1100	1300	1300	1500	-	-	-	-
700	900	1050	1260	1400	1700	2100	2650
-	-	-	-	-	-	-	-
-	-	-	-	-	-	-	-
150	200	200					
200	250	300					
400	500	600					
400	500	600					
6	-	7	-	-	-	-	-
	22.2		24		33.8		47
	285×310×246		285×352×246		431×380×246		431×392×246

2NO2NC	2NO2NC	2NO2NC
AU-100, AU-100E (Max.4NO4NC)	AU-100, AU-100E (Max.4NO4NC)	AU-100, AU-100E (Max.4NO4NC)
-	-	-



MT-800/□
●
690
690
6k
10A, 20
200~800A
11.5
360×530×212

Contactors

Metasol MC 4P 18 to 85A



MC type Magnetic Contactors

Frame size				18AF			
Type				MC-6a/4	MC-9a/4	MC-12a/4	MC-18a/4
Screw clamp terminal				●			
Number of poles				4pole			
Rated operational voltage (Ue)				690V			
Rated insulation voltage (Ui)				690V			
Rated frequency				50/60Hz			
Rated impulse withstand voltage, Uimp				6kV			
Maximum operating rate in operating cycles per hour(AC1)				1800 operations per hour			
Durability		Mechanical		15 mil. operations			
		Electrical		0.5 mil. operations		0.8 mil. operations	
Current and Power	Thermal current		[A]	25	25	25	40
	AC-1	200/240V	[kW]	9	9	9	15
			[A]	25	25	25	40
		380/440V	[kW]	17	17	17	27
			[A]	25	25	25	40
		500/550V	[kW]	21	21	21	35
			[A]	25	25	25	40
		690V	[kW]	27	27	27	44
		[A]	25	25	25	40	
UL rating (50/60Hz)	Continuous current		A	25	25	25	32
	Single	110-120V	[HP]	0.5	0.5	0.75	1
		Phase	220-240V	[HP]	1.5	1.5	2
	Three	200-208V	[HP]	2	2	3	7.5
		Phase	220-240V	[HP]	3	3	5
		440-480V	[HP]	5	5	7.5	10
	550-600V	[HP]	7.5	7.5	10	15	
Size and weight	AC control	Weight	[kg]	0.33			
		Size(W×H×D)	[mm]	45×73.5×80.4			
	DC control	Weight	[kg]	0.4			
		Size(W×H×D)	[mm]	45×73.5×96.6			
Auxiliary(standard)				-			
Auxiliary	Side mount			UA-1			
	Front mount			UA-2, UA-4			



22AF	40AF		85AF			
MC-12a/4	MC-32a/4	MC-40a/4	MC-50a/4	MC-65a/4	MC-75a/4	MC-85a/4
●	●				●	
4pole	4pole				4pole	
690V	690V				690V	
690V	690V				1000V	
50/60Hz	50/60Hz				50/60Hz	
6kV	6kV				8kV	
1800 operations per hour	1800 operations per hour				1800 operations per hour	
15 mil. operations	15 mil. operations				12 mil. operations	
1 mil. operations	1 mil. operations				1 mil. operations	
40	50	60	80	100	110	135
15	18	22	30	37	41	51
40	50	60	80	100	110	135
27	35	42	56	70	76	95
40	50	60	80	100	110	135
35	43	52	70	88	97	120
40	50	60	80	100	110	135
44	55	66	88	110	120	150
40	50	60	80	100	110	135
32	45	50	70	80	90	100
2	2	3	3	5	5	7.5
3	5	5	7.5	10	15	15
7.5	7.5	10	10	15	20	25
7.5	10	10	15	20	25	30
10	20	25	30	40	50	50
15	20	25	30	40	50	50
0.4	0.59				1.2	
47.2×80×86.8	59×83.5×94.5				91×123.5×117.8	
0.5	0.7				1.29	
47.2×80×113.2	59×83.5×121				91×123.5×117.8	
-	-				-	
UA-1	UA-1				UA-1	
UA-2, UA-4	UA-2, UA-4				UA-2, UA-4	

Contactors

Metasol MC 4P 225 to 800A

MC type Magnetic Contactors



Frame size				225AF					
Type				MC-100a/4	MC-130a/4	MC-150a/4	MC-185a/4	MC-225a/4	
Screw clamp terminal				●					
Number of poles				4					
Rated operational voltage (Ue)				690					
Rated insulation voltage (Ui)				1000					
Rated frequency				50/60					
Rated impulse withstand voltage, Uimp				8					
Maximum operating rate in operating cycles per hour(AC1)				1200					
Durability				500					
Mechanical				80					
Electrical				80					
Current and Power	Thermal current [A]			200	250	275	300	350	
	AC-1	200/240V	[kW]	57	60	76	87	100	
		380/440V	[kW]	106	110	142	165	185	
	AC-3	200/240V	[A]	200	250	275	300	350	
		380/440V	[A]	200	250	275	300	350	
		500/550V	[kW]	132	137	180	205	230	
		690V	[kW]	165	170	225	255	290	
	UL rating (50/60Hz)	Continuous current A			200	250	275	300	350
Single		110-120V	[HP]	7.5	10	15	15	15	
		Phase	220-240V	[HP]	15	20	25	30	40
Three		200-208V	[HP]	30	40	40	60	60	
		Phase	220-240V	[HP]	30	40	50	60	75
		440-480V	[HP]	60	75	100	125	150	
		550-600V	[HP]	60	75	100	125	150	
Size and weight		AC control	Weight	[kg]	5.6				
	Size(W×H×D)		[mm]	175×203×185					
	DC control	Weight	[kg]	5.6					
		Size(W×H×D)	[mm]	175×203×185					
Auxiliary(standard)				2NO2NC					
Auxiliary				AU-100, AU-100E					
Side mount									
Front mount									

* - FLA = 722 A, LRA = 5618 A
 ** - FLA = 566 A, LRA = 4495 A



400AF			800AF		
MC-265a/4	MC-330a/4	MC-400a/4	MC-500a/4	MC-630a/4	MC-800a/4
	●			●	
	4			4	
	690			690	
	1000			1000	
	50/60			50/60	
	8kV			8	
	1200			1200	
	250			250	
	50			50	
400	500	520	700	900	1050
115	135	160	245	255	310
400	500	520	700	900	1050
215	250	300	450	470	570
400	500	520	700	900	1050
265	315	375	560	590	710
400	500	520	700	900	1050
335	390	470	710	740	900
400	500	520	700	900	1050
400	500	520	700	900	1050
-	-	-	-	-	-
-	-	-	-	-	-
75	100	125	150	200	200
100	100	150	200	250	300
200	200	300	400	500	600 *
200	200	300	400	500	600 **
	9.9			26.3	
	206×243×205			346×310×244	
	9.9			26.3	
	206×243×205			346×310×244	
2NO2NC			2NO2NC		
AU-100, AU-100E			AU-100, AU-100E		
-			-		

Contactors

Metasol MCI 3P 1260 to 2650A

Renewable Magnetic Contactor

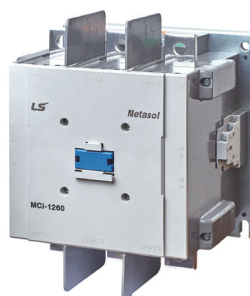

- Eco-friendly contact material applied (Cd free)
- Type 2 coordination data with MCCB or ACB

Frame size			1260AF			
Type			MCI-900	MCI-1050	MCI-1260	
Screw clamp terminals				●		
Number of poles		pole		3		
Rated operational voltage (Ue)		Vac		1000		
Rated insulation voltage (Ui)		Vac		1000		
Rated frequency		Hz		50/60		
Rated impulse withstand voltage (Uimp)		kV		8		
Mechanical operating cycle		cycles/hour	600	600	300	
Electrical operating cycle		cycles/hour	600	600	300	
Durability	Mechanical	million	100	100	50	
	Electrical (AC-1@690V)	million	26	26	15	
	Electrical (AC-1@400V)	million	50	50	20	
Current and Power (IEC)	AC-1 1000V 55/60/70°C	A	900/850/700	1050/875/720	1260/1060/900	
	Thermal current	A	900	1050	1260	
	Heat dissipation	W	100	170	170	
Rated Short-time withstand current(Icw) (IEC 60947)	1s	A	7000	7500	8000	
	10s	A	6400	7000	7200	
	1min	A	3500	3800	4000	
	10min	A	1550	1550	2300	
max. breaking capacity (Icd)	400V	A	6000	7500	7500	
	690V	A	5000	7000	7000	
	1000V	A	2000	2500	2500	
Type-2 Coordination (with MCCB or ACB)			kA			
			42kA (Break time: less than 20ms)			
Current and HP (UL)	Thermal current		900	1050	1260	
	Single phase	110~120V	HP	-	-	-
		220~240V	HP	-	-	-
	Three phase	200~208V	HP	200	200	-
		220~240V	HP	250	300	-
		440~480V	HP	500	600	-
550~600V		HP	500	600	-	
Weight (kg)			22.2	22.2	25	
Size (W×H×D)			mm	285×310×246	285×310×246	285×352×246
Auxiliary(standard)			2NO2NC			
Auxiliary	Side Mount		AU-100, AU-100E (max.4NO4NC)			
	Front Mount		-			

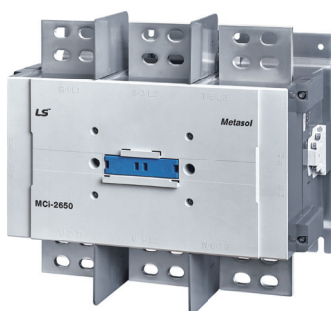

2650AF		
MCI-1700	MCI-2100	MCI-2650
	●	
	3	
	1000	
	1000	
	50/60	
	8	
	300	
300	300	120
50	50	30
5	5	2
5	5	5
1700/1450/1300	2100/1750/1500	2650/2350/2150
1700	2100	2650
220	350	350
	12000	
	10000	
	5500	
	3000	
9000	12000	1200
8000	8500	8500
3000	3150	3150
	42kA (Break time: less than 50ms)	
1700	2100	2650
-	-	-
-	-	-
-	-	-
-	-	-
-	-	-
34.6	34.6	47
431×380×246	431×380×246	431×392×246
2NO2NC		
AU-100, AU-100E (max.4NO4NC)		
-		

Mini Contactors

Mini MC 6~16A

Mini contactors

3NO main contacts
1 auxiliary contacts

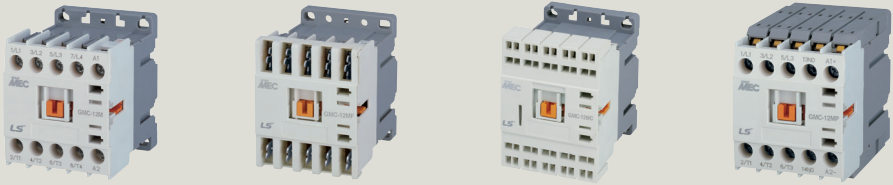

Screw clamp type Fast-on type Cage clamp type Solder pin type

Frame size		6A		9A		12A		16A	
Screw clamp type	AC coil	GMC-6M		GMC-9M		GMC-12M		GMC-16M	
	DC coil	GMD-6M		GMD-9M		GMD-12M		GMD-16M	
Fast-on type	AC coil	GMC-6MF		GMC-9MF		GMC-12MF		GMC-16MF	
	DC coil	GMD-6MF		GMD-9MF		GMD-12MF		GMD-16MF	
Cage clamp type	AC coil	GMC-6MC		GMC-9MC		GMC-12MC		GMC-16MC	
	DC coil	GMD-6MC		GMD-9MC		GMD-12MC		GMD-16MC	
Solder pin type	AC coil	GMC-6MP		GMC-9MP		GMC-12MP		GMC-16MP	
	DC coil	GMD-6MP		GMD-9MP		GMD-12MP		GMD-16MP	
Ratings / IEC60947-4		kW	A	kW	A	kW	A	kW	A
AC1		20		20		20		20	
	200/240V	1.5	7	2.2	9	3	12	4	16
AC3	380/440V	2.2	6	4	9	5.5	12	7.5	16
	500/550V	3	5	3.7	6	4	7	5.5	9
	690V	3	4	4	5	4	5	4	5
Ratings / UL508		hp	A	hp	A	hp	A	hp	A
continuous current		lth = 20A (maximum for cage clamp type is 10A)							
single phase	120V	1/2		1/2		1 *		-	
	230V/240V	1		1.5		2 **		-	
three phase	240V	1.5		3		3		-	
	480V	3		5		7.5 ***		-	
	600V	3		5		7.5		-	
Wire Range:		Copper, 75°C, Stranded, 18-12AWG							
NEMA size		00		00		00		0	
Additional auxiliary contacts		Screw clamp type		Fast-on type		Cage clamp type		Solder pin type	
2-pole, Front mount		AU-2M		AU-2MF		AU-2MC		AU-1MP	
	4-pole, Front mount	AU-4M		AU-4MF		AU-4MC			
	2-pole, Side mount	AU-1M		AU-1MF		AU-1MC			

Note) * = 1/2 for cage clamp type, ** = 1.5hp for cage clamp type, *** = 5hp for cage clamp type
16AF : not approved from UL

Overload Relays

Bimetallic style
Type GT

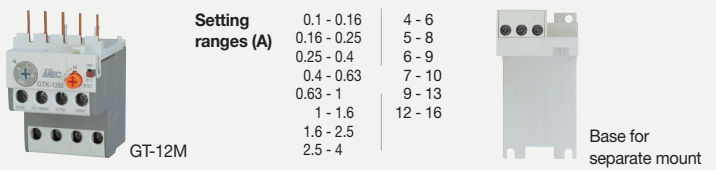

Setting ranges (A)

0.1 - 0.16	4 - 6
0.16 - 0.25	5 - 8
0.25 - 0.4	6 - 9
0.4 - 0.63	7 - 10
0.63 - 1	9 - 13
1 - 1.6	12 - 16
1.6 - 2.5	
2.5 - 4	

Base for separate mount

Differential	GTK-12M
Non-differential (3-heater)	GTH-12M/3
Non-differential (2-heater)	GTH-12M

DMPi Series



DMPi

Rated specifications

Connection method		Penetrated / Terminal type
Protection functions		Overcurrent, phase fail, phase unbalance, stall, locked rotor, reverse phase, ground fault (Type option) Instance (Type option)
Connection method		Penetrated / Terminal type
Operating time characteristics		Thermal heat build-up inverse time / Non-thermal heat build-up inverse time / Definite time
Rated current		0.5~6A/5~65A(Rating option upon placing an order)
Display		4 digit, 7-Segment
Operating power		AC/DC 85~260V(50Hz/60Hz)
Reset method	Automatic	1~20min (only for overcurrent)
	Manual	(Electrical reset)
Installation / Mounting method		Display can be installed separately, 35mm DIN rail / Screw installation
Tolerance	Current	±3%
	Time	±5%
	4~20mA output	±5%
Time setting	Startup delay	1~200sec
	Operation delay	1~60sec
Aux. contact	Composition	3-SPST(Power supply 1a1b, instantaneous operation 1a) ^{Note1)}
	Capacity	3A/250VAC Resistive Load
	Contact minimum load	100mA / 6VDC : (95-996, 97-98) 10mA / 5VDC (07-08)
ZCT Input	External	200mA/100mV(Exclusive ZCT) ^{Note2)}
	Built-in	Support (Separate connection unnecessary) ^{Note2)}
Service environment	Service temperature	-20°C ~ 60°C
	Storage temperature	-30°C ~ 70°C
	Relative humidity	Below 50% RH (Without condensation)
Insulation resistance		100MΩ/500VDC
Lightning impulse voltage		1.2X50us 5kV Prototype waveform supply
Fast transient		2kV/1Min
Power consumption		Below 2W

Note) 1. See No. 21 to 23 of A-Group in Setting Menu if single phase is set, the device measures R/S/T phase. In HMI, the maximum phase of three phases is displayed without any indication of phase.

2. It is used when zero current detection type is selected.

3. This product is used to protect a low-voltage motor with 1000V or less

Manual Motor Starters

Metasol Series ... IEC rating

MMS



Terminal cover detachable type



Terminal cover detachable type

Frame			32AF																					
Type	Current adjustable type	MMS-32D	MMS-32S										MMS-32H											
	Instantaneous type	-	Standard										High breaking											
Breaking capacity			Standard										High breaking											
Handle type			Toggle										Rotary											
Number of poles			3										3											
Rated operational voltage (Ue)			AC 400/415V										Up to 690V											
Rated frequency			50/60Hz										50/60 Hz											
Rated insulation voltage (Ui)			690V										690V											
Rated impulse voltage (Uimp)			6kV										6kV											
Utilization category IEC 60 947-2 (Breaker)			Cat. A										Cat. A											
Utilization category IEC 60 947-4 (Motor starter)			AC 3										AC 3											
Mechanical endurance (Operating)			100,000										100,000											
Electrical endurance (Cycles)			100,000										100,000											
Max operating frequency per hour (Ope./h)			25										25											
Temperature compensation (Operation)			-5 ~ +40°C										-20 ~ +60°C											
Instantaneous short circuit release			14.4 × Ie max.										13 × Ie max.											
Overload protection			○										MMS-32H(○), MMS-32HI(x)											
Phase failure function			○										MMS-32H(○), MMS-32HI(x)											
Trip indicating function			x										○											
Test function			○										○											
Weight (g)			285										320											
Rated breaking capacity (kA)	Rated operational current (Ie) / (MMS-32D)	Thermal release adjustment range (Ie) / (MMS-32D)	415V 400V		240V 230V 220V		415V 400V		460V 440V		525V 500V		690V 600V		240V 230V 220V		415V 400V		460V 440V		525V 500V		690V 600V	
			Icu	Ics	Icu	Ics	Icu	Ics	Icu	Ics	Icu	Ics	Icu	Ics	Icu	Ics	Icu	Ics	Icu	Ics	Icu	Ics	Icu	Ics
	0.16	0.1~0.16	100	100	100	100	100	100	100	100	100	100	100	100	100	100	100	100	100	100	100	100	100	100
	0.25	0.16~0.25	100	100	100	100	100	100	100	100	100	100	100	100	100	100	100	100	100	100	100	100	100	100
	0.4	0.25~0.4	100	100	100	100	100	100	100	100	100	100	100	100	100	100	100	100	100	100	100	100	100	100
	0.63	0.4~0.63	100	100	100	100	100	100	100	100	100	100	100	100	100	100	100	100	100	100	100	100	100	100
	1	0.63~1	100	100	100	100	100	100	100	100	100	100	100	100	100	100	100	100	100	100	100	100	100	100
	1.6	1~1.6	100	100	100	100	100	100	100	100	100	100	3	3	100	100	100	100	100	100	100	100	100	100
	2.5	1.6~2.5	100	100	100	100	100	100	100	100	50	38	3	3	100	100	100	100	100	100	100	100	8	8
	4	2.5~4	100	100	100	100	100	100	50	38	15	11	3	3	100	100	100	100	100	100	100	100	8	8
	6/(6.3)	4~6/(4~6.3)	100	100	100	100	100	100	15	11	10	8	3	3	100	100	100	100	100	100	100	100	6	6
	8	5~8	-	-	100	100	100	100	15	11	10	8	3	3	100	100	100	100	50	38	50	38	6	6
	10	6~10	100	100	100	100	50	38	15	11	6	5	3	3	100	100	100	100	50	38	50	38	6	6
	13/(14)	9~13/(9~14)	15	7.5	100	100	50	38	10	8	6	5	3	3	100	100	100	100	50	38	42	32	6	6
	17/(18)	11~17/(13~18)	15	7.5	50	38	20	15	10	8	6	5	3	3	100	100	50	38	25	15	10	8	4	4
	22/(23)	14~22/(17~23)	15	6	40	30	15	11	8	6	6	5	3	3	100	100	50	38	25	15	10	8	4	4
	26/(25)	18~26/(20~25)	15	6	40	30	15	11	8	6	5	4	3	3	100	100	50	38	25	15	10	8	4	4
	32	22~32/(24~32)	10	6	30	22	15	11	6	4	5	4	3	3	100	100	50	38	25	15	10	8	4	4
	40	28~40	-	-	20	15	10	8	5	3	4	3	2	2	100	100	40	30	15	11	8	6	3	3
	50	34~50	-	-	-	-	-	-	-	-	-	-	-	-	-	-	-	-	-	-	-	-	-	-
	63	45~63	-	-	-	-	-	-	-	-	-	-	-	-	-	-	-	-	-	-	-	-	-	-
	65	47~65	-	-	-	-	-	-	-	-	-	-	-	-	-	-	-	-	-	-	-	-	-	-
	75	55~75	-	-	-	-	-	-	-	-	-	-	-	-	-	-	-	-	-	-	-	-	-	-
	90	70~90	-	-	-	-	-	-	-	-	-	-	-	-	-	-	-	-	-	-	-	-	-	-
	100	80~100	-	-	-	-	-	-	-	-	-	-	-	-	-	-	-	-	-	-	-	-	-	-

Note) 1. Safety certification is obtained based on 220V and 460V.
 2. There is no current adjustment range for HI products.



	63AF															100AF														
	MMS-63S					MMS-63H					MMS-100S					MMS-100H														
	-					MMS-63HI					-					MMS-100HI														
	Standard					High breaking					Standard					High breaking														
	Rotary					Rotary					Rotary					Rotary														
	3					3					3					3														
	Up to 690V					Up to 690V					Up to 690V					Up to 690V														
	50/60 Hz					50/60 Hz					50/60 Hz					50/60 Hz														
	1000V					1000V					1000V					1000V														
	8kV					8kV					8kV					8kV														
	Cat. A					Cat. A					Cat. A					Cat. A														
	AC 3					AC 3					AC 3					AC 3														
	50,000					50,000					50,000					50,000														
	25,000					25,000					25,000					25,000														
	25					25					25					25														
	-20 ~ +60°C					-20 ~ +60°C					-20 ~ +60°C					-20 ~ +60°C														
	13 x Ie max.					13 x Ie max					13 x Ie max.					13 x Ie max.														
	○					MMS-63H(○), MMS-63HI(x)					○					MMS-100H(○), MMS-100HI(x)														
	○					MMS-63H(○), MMS-63HI(x)					○					MMS-100H(○), MMS-100HI(x)														
	○					○					○					○														
	○					○					○					○														
	1,000					1,000					2,200					2,200														
	240V 230V 220V	415V 400V	460V 440V	252V 500V	690V 600V	240V 230V 220V	415V 400V	460V 440V	525V 500V	690V 600V	240V 230V 220V	415V 400V	460V 440V	525V 500V	690V 600V	240V 230V 220V	415V 400V	460V 440V	525V 500V	690V 600V										
	Icu	Ics	Icu	Ics	Icu	Ics	Icu	Ics	Icu	Ics	Icu	Ics	Icu	Ics	Icu	Ics	Icu	Ics	Icu	Ics										
	-	-	-	-	-	-	-	-	-	-	-	-	-	-	-	-	-	-	-	-										
	-	-	-	-	-	-	-	-	-	-	-	-	-	-	-	-	-	-	-	-										
	-	-	-	-	-	-	-	-	-	-	-	-	-	-	-	-	-	-	-	-										
	-	-	-	-	-	-	-	-	-	-	-	-	-	-	-	-	-	-	-	-										
	-	-	-	-	-	-	-	-	-	-	-	-	-	-	-	-	-	-	-	-										
	-	-	-	-	-	-	-	-	-	-	-	-	-	-	-	-	-	-	-	-										
	-	-	-	-	-	-	-	-	-	-	-	-	-	-	-	-	-	-	-	-										
	-	-	-	-	-	-	-	-	-	-	-	-	-	-	-	-	-	-	-	-										
	-	-	-	-	-	-	-	-	-	-	-	-	-	-	-	-	-	-	-	-										
	-	-	-	-	-	-	-	-	-	-	-	-	-	-	-	-	-	-	-	-										
	-	-	-	-	-	-	-	-	-	-	-	-	-	-	-	-	-	-	-	-										
	-	-	-	-	-	-	-	-	-	-	-	-	-	-	-	-	-	-	-	-										
	100	100	100	100	15	12	10	8	4	3	100	100	100	100	50	38	50	38	6	5										
	100	100	50	38	10	8	6	5	4	3	100	100	100	100	50	38	42	32	6	5										
	100	100	25	19	10	8	6	5	4	3	100	100	50	50	50	38	12	9	5	5										
	50	38	25	19	10	8	6	5	4	3	100	100	50	50	50	38	12	9	5	5										
	50	38	25	19	10	8	6	5	4	3	100	100	50	50	35	27	12	9	5	5										
	50	38	25	19	10	8	6	5	4	3	100	100	50	50	35	27	10	8	5	5										
	50	38	25	19	10	8	6	5	4	3	100	100	50	50	35	27	10	8	5	5										
	50	38	25	19	10	8	6	5	4	3	100	100	50	50	35	27	10	8	5	5										
	50	38	25	19	10	8	6	5	4	3	100	100	50	50	35	27	10	8	5	5										
	50	38	25	19	10	8	6	5	4	3	75	50	35	27	25	19	6	5	3	3										
	-	-	-	-	-	-	-	-	-	-	-	-	-	-	-	-	-	-	-	-										
	-	-	-	-	-	-	-	-	-	-	-	-	-	-	-	-	-	-	-	-										
	-	-	-	-	-	-	-	-	-	-	-	-	-	-	-	-	-	-	-	-										

Molded Case Circuit Breakers

Susol MCCB 100AF to 800AF Series

MCCB

Type			TE100		TE160		TD100			TD160		
Frame size	[AF]		100		160		100			160		
Rated current, I _n *	[A]		16~100		100, 125, 160		16, 20, 25, 32, 40, 60, 63, 80, 100			100, 125, 160, 1P: 16~160		
No. of poles			3,4		3,4		2*, 3, 4			1, 2*, 3, 4		
Rated operational voltage, U _e	AC	[V]	690		690		690			690, 1P; 240		
	DC	[V]	500		500		500			500, 1P:250		
Rated impulse withstand voltage, U _{imp}		[kV]	8		8		8			8		
Rated insulation voltage, U _i		[V]	750		750		1000			1000		
Rated ultimate short-circuit breaking capacity, I _{cu}			S	N	S	N	N	H	L	N	H	L
AC 50/60Hz	220/240V	[kA]	50	85	50	85	85	100	200	85 (1P:30)	100 (1P:50)	200
	380/415V	[kA]	37	50	37	50	50	85	150	50	85	150
	440/460V	[kA]	25	37	25	37	50	70	130	50	70	130
	480/500V	[kA]	18	25	18	25	30	50	65	30	50	65
	525V	[kA]	-	-	-	-	22	35	50	22	35	50
	660/690V	[kA]	6	8	6	8	10	10	10	10	10	10
DC	250V	[kA]	37	50	37	50	42	65	100	42 (1P:16)	65 (1P:25)	100
	500V (2poles in series)	[kA]	37	50	37	50	42	65	100	42	65	100
Rated service breaking capacity, I _{cs}												
AC 50/60Hz	220~525V	[%I _{cu}]	100%	100%	100%	100%	100%	100%	100%	100%	100%	100%
	660/690V	[kA]	-	-	-	-	5	5	5	5	5	5
DC		[%I _{cu}]	100%	100%	100%	100%	100%	100%	100%	100%	100%	100%
Rated short-circuit making capacity I _{cm}												
AC 50/60Hz	220/240V	[kA]	105	187	105	187	187	220	440	187 (1P:105)	220 (1P:105)	440
	380/415V	[kA]	77.7	105	77.7	105	105	187	330	105	187	330
	440/460V	[kA]	52.5	77.7	52.5	77.7	105	154	286	105	154	286
	480/500V	[kA]	36	52.5	36	52.5	63	105	143	63	105	143
	525V	[kA]	-	-	-	-	46	74	105	46	74	105
	660/690V	[kA]	9.2	13.6	9.2	13.6	17	17	17	17	17	17
Category of utilization			A		A		A			A		
Isolation behavior			●		●		●			●		
Trip unit (release)												
Thermal-Magnetic												
● fixed-thermal, fixed-magnetic	FTU		●	●	●	●	●	●	●	●	●	●
● adjustable-thermal, fixed-magnetic	FMU		●	●	●	●	●	●	●	●	●**	●
● adjustable-thermal, adjustable-magnetic	ATU		-	-	-	-	-	-	-	-	-	-
● magnetic only	MTU		-	-	-	-	-	-	-	-	-	-
Electronic												
● LSI	ETS		-	-	-	-	-	-	-	-	-	-
● LSI	ETM		-	-	-	-	-	-	-	-	-	-
Option												
Earth-fault protection, I _g			-	-	-	-	-	-	-	-	-	-
Zone selective interlocking, ZSI			-	-	-	-	-	-	-	-	-	-
Ammeter			-	-	-	-	-	-	-	-	-	-
Communication			-	-	-	-	-	-	-	-	-	-
Earth-leakage protection module			-	-	-	-	-	-	-	-	-	-
Connection	fixed	front-connection	●	●	●	●	●	●	●	●	●	●
		rear-connection	●	●	●	●	●	●	●	●	●**	●
	plug-in	front-connection	-	-	-	-	-	-	-	-	-	●**
		rear-connection	-	-	-	-	-	-	-	-	-	●**
Mechanical life	[operations]	25000		25000		25000			25000			
Electrical life @ 415 V AC	[operations]	10000		10000		10000			10000			
Basic dimensions, W×H×D (front connection)	1-pole	[mm]	-		-		-			35×140×86		
	3-pole	[mm]	76×130×82		76×130×82		90×140×86			90×140×86		
	4-pole	[mm]	101×130×82		101×130×82		120×140×86			120×140×86		
Weight (front connection)	1-pole	[kg]	-		-		-			0.57		
	3-pole	[kg]	1.05		1.05		1.5			1.5		
	4-pole	[kg]	1.35		1.35		1.8			1.8		
Reference standard		IEC60947-2		IEC60947-2		IEC60947-2			IEC60947-2			

Note) ● applicable or available

* Applicable to MCCBs equipped with FTU, FMU, ATU ** Not applicable to 1pole
* 2 pole MCCB in 3pole frame size

※ The trip unit ATU is available from 125A



TS100			TS160			TS250			TS400			TS630			TS800		
100			160			250			400			630			800		
40, 50, 63, 80, 100			(100)※, 125, 160			125, 160, 200, 250			300, 400			500, 630			700, 630		
2*, 3, 4			2*, 3, 4			2*, 3, 4			2*, 3, 4			2*, 3, 4			2*, 3, 4		
690			690			690			690			690			690		
500			500			500			500			500			500		
8			8			8			8			8			8		
1000			1000			1000			1000			1000			1000		
N	H	L	N	H	L	N	H	L	N	H	L	N	H	L	N	H	L
100	120	200	100	120	200	100	120	200	100	120	200	100	120	200	100	120	200
50	85	150	50	85	150	50	85	150	50	85	150	50	85	150	50	85	150
50	70	130	50	70	130	50	70	130	50	70	130	50	70	130	50	70	130
42	65	85	42	65	85	42	65	85	42	65	85	42	65	85	42	65	85
22	35	50	22	35	50	22	35	50	22	35	50	22	35	50	22	35	50
10	10	10	10	10	10	10	10	10	10	10	20	10	20	35	10	20	35
50	85	100	50	85	100	50	85	100	50	85	100	50	85	100	50	85	100
50	85	100	50	85	100	50	85	100	50	85	100	50	85	100	50	85	100
100%	100%	100%	100%	100%	100%	100%	100%	100%	100%	100%	100%	100%	100%	100%	100%	100%	100%
5	5	5	5	5	5	5	5	5	5	10	12	10	12	12	10	20	20
100%	100%	100%	100%	100%	100%	100%	100%	100%	100%	100%	100%	100%	100%	100%	100%	100%	100%
220	264	440	220	264	440	220	264	440	220	264	440	220	264	440	220	264	440
105	187	330	105	187	330	105	187	330	143	187	330	143	187	330	143	220	330
105	154	286	105	154	286	105	154	286	143	187	286	143	187	286	143	220	286
88	143	187	88	143	187	88	143	187	88	143	187	88	143	187	88	187	220
46	74	105	46	74	105	46	74	105	46	74	105	46	74	105	46	74	105
17	17	17	17	17	17	17	17	17	17	40	74	17	40	74	17	40	74
	A			A			A			A			A			A	
	●			●			●			●			●			●	
	●			●			●			●			●			●	
	●			●			●			●			●			●	
	-			●			●			●			●			●	
	●			●			●			●			●			●	
	●			●			●			●			●			●	
	●			●			●			●			●			●	
	●			●			●			●			●			●	
	●			●			●			●			●			●	
	●			●			●			●			●			●	
	●			●			●			●			●			●	
	●			●			●			●			●			●	
	●			●			●			●			●			●	
	●			●			●			●			●			●	
	●			●			●			●			●			●	
	●			●			●			●			●			●	
	●			●			●			●			●			●	
	●			●			●			●			●			●	
	●			●			●			●			●			●	
25000			25000			25000			20000			20000			10000		
10000			10000			10000			10000			6000			3000		
-			-			-			-			-			-		
105x160x86			105x160x86			105x160x86			140x260x110			140x260x110			210x320x135		
140x160x86			140x160x86			140x160x86			186.5x260x110			186.5x260x110			280x320x135		
-			-			-			-			-			-		
2			2			2			5.4			5.4			15.1		
2.6			2.6			2.6			7.2			7.2			19.6		
IEC60947-2			IEC60947-2			IEC60947-2			IEC60947-2			IEC60947-2			IEC60947-2		

Calibrated for 40°C	Amb. Temp.	-5°C	0°C	10°C	20°C	25°C	30°C	35°C	40°C	45°C	50°C
	TD160	122.5%	120.0%	115.0%	110.0%	107.5%	105.0%	102.5%	100.0%	97.5%	95.0%
TS250	122.5%	120.0%	115.0%	110.0%	107.5%	105.0%	102.5%	100.0%	97.5%	95.0%	
TS630	110.0%	109.0%	107.0%	105.0%	104.0%	103.0%	101.5%	100.0%	98.5%	97.0%	
TS800	110.0%	109.0%	107.0%	105.0%	104.0%	103.0%	101.5%	100.0%	98.5%	97.0%	
Calibrated for 50°C	TD160	122.0%	120.0%	116.0%	112.0%	110.0%	108.0%	106.0%	104.0%	102.0%	100.0%
	TS250	122.0%	120.0%	116.0%	112.0%	110.0%	108.0%	106.0%	104.0%	102.0%	100.0%
	TS630	122.2%	112.0%	110.0%	108.0%	107.0%	106.0%	104.5%	103.0%	101.5%	100.0%
	TS800	112.2%	112.0%	110.0%	108.0%	107.0%	106.0%	104.5%	103.0%	101.5%	100.0%

Molded Case Circuit Breakers

Susol MCCB 1600AF Series







Electrical characteristics

			TS1000			TS1250			TS600			
Type			TS1000			TS1250			TS1600			
Ampere frame			1000			1250			1600			
Pole			3, 4			3, 4			3, 4			
Rated current, (A)	In	-5~40°C	800, 1000			1250			1600			
		50°C	800, 1000			1250			1560			
		65°C	800, 1000			1240			1420			
Rated insulation voltage, (V)	Ui	1000			1000			1000				
Rated impulse withstand voltage, (kV)	Uimp	8			8			8				
Rated operational voltage, (V)	Ue	AC50/60Hz	690			690			690			
		DC	-			-			-			
Rated short-circuit breaking capacity			N	H	L	N	H	N	H			
IEC60947-2 AC50/60Hz (sym)	Rated ultimate short-circuit breaking capacity, (kA) (Icu)	220/240V	55	75	200	55	75	55	75	55	75	
		380/415V	50	70	150	50	70	50	70	50	70	
		440/460V	50	65	130	50	65	50	65	50	65	
		480/500V	40	50	100	40	50	40	50	40	50	
		660/690V	35	45	-	35	45	35	45	35	45	
DC	250V 2P	-	-	-	-	-	-	-	-	-		
	500V 2P	-	-	-	-	-	-	-	-	-		
	750V 3P	-	-	-	-	-	-	-	-	-		
Rated service breaking capacity (Ics)		%Icu	100%	75%	100%	100%	75%	100%	75%	100%	75%	
Rated short-time withstand current (kA) (Icw)		1s	25			25			25			
		3s	-			-			-			
Overriding instantaneous protection		kA peak	50		30	50		50	50			
Isolation			○			○			○			
Category			B		A	B		B	B			
Life cycle Note 1)	Mechanical (operations)		10000			4000			10000			
	Electrical (operations)	440V	In/2	6000			4000			5000		
			In	5000			3000			4000		
	690V	In/2	4000			3000			3000			
In		2000			2000			2000				
Pollution degree			3			3			3			
Dimension (mm)		3-pole	210×327×152.5									
(W×H×D)		4-pole	280×327×152.5									
Weight (kg)		3-pole	13									
		4-pole	16.8									

Note) 1. Life cycle does not mean guarantee but limitation
(Quality guarantee: On/Off frequency on the basis of IEC60947-2 within the term of guarantee.)

Overview

Classification	N type	A type	P type	S type
Externals				
Current protection	• L / S / I / G / Thermal	• L / S / I / G / Thermal • ZSI(Protective coordination)	• L / S / I / G / Thermal(Continuous) • ZSI(Protective coordination)	• P type
Other protection	-	• Earth leakage (Option)	• Earth leakage(Option) • Over/Under current • Over/Under frequency • Unbalance(Voltage/Current) • Reverse power	• P type
Measurement function	-	• Current (R / S / T / N)	• 3 Phase Voltage/Current RMS/ Vector • Power(P, Q, S), PF(3-Phase) • Energy(Positive/Negative) • Frequency, Demand	• 3 Phase Voltage/Current RMS/ Vector • Power(P, Q, S), PF(3-Phase) • Energy(Positive/Negative) • Frequency, Demand • Voltage/Current harmonics (1st-63th) • 3 Phase Waveforms • THD, TDD, K-Factor
Fine adjustment	-	-	• Fine adjustment for long/short time delay/instantaneous/ ground	• P type
Pre Trip Alarm	-	-	• Overload protection relays : DO (Alarm) (Ground fault is not available when using Pre trip alarm)	• P type
Digital Output	-	• 3DO (Fixed) • L, S/I, G Alarm	• 3DO (Programmable) • Trip, Alarm, General	• P type
IDMTL setting	-	-	• Compliance with IEC60255-3 SIT, VIT, EIT, DT	• P type
Communication	-	• Modbus/RS-485 • Profibus-DP	• Modbus/RS-485 • Profibus-DP	• Modbus/RS-485 • Profibus-DP
Power supply	• Self Power - Power source works over 25% of current of In (one pole)	• Self Power - Power source works over 25% of current of In (one pole) - External power source is required for comm. • AC/DC 100~250V • DC 24~60V	• AC/DC 100~250V • DC 24~60V Basic protection function(L/S/I/G) is still under normal operation without control power.	• AC/DC 100~250V • DC 24~60V Basic protection function(L/S/I/G) is still under normal operation without control power.
RTC timer	• Available	• Available	• Available	• Available
LED for trip info.	• Long time delay • Short time delay/Instantaneous • Ground fault	• N type	• N type	• N type
Fault recording	-	• 256 records	• 256 records (Fault/Current/Date and Time)	• 256 records • Last fault wave recording (3 Phase)
Event recording	-	-	• 256 records (Content, Status, Date)	• P type
Operating button	• Reset button	• Reset, Menu Up/Down, Left/Right, Enter	• A type	• A type

Molded Case Circuit Breakers

Metasol 30AF to 250AF Series

MCCB

Frame Size (AF)		30	50		60		
Type		S-Type	N-Type	S-Type	H-Type	N-Type	S-Type
Type and Pole	2 pole	ABS32c	ABN52c	ABS52c	ABH52c	ABN62c	ABS62c
	3 pole	ABS33c	ABN53c	ABS53c	ABH53c	ABN63c	ABS63c
	4 pole	ABS34c	ABN54c	ABS54c	ABH54c	ABN64c	ABS64c
Rated current, I _n	(A)	(3, 5, 10) 15, 20, 30	15, 20, 30, 40, 50		15, 20, 30, 40, 50	15, 20, 30, 40, 50, 60	
Rated operational voltage, U _e	AC(V)	690	690	690	690	690	690
	DC(V)	500	500	500	500	500	500
Rated insulation voltage, U _i	(V)	1000	1000	1000	1000	1000	1000
Rated impulse withstand voltage, U _{imp}	(kV)	8	8	8	8	8	8
Rated short-circuit breaking capacity(I _{cu}) kA (Sym), KSC8321, IEC 60947-2							
AC	690V	2.5	2.5	5	10	2.5	5
	480/500V	7.5	7.5	10	35	7.5	10
	415/460V	14 (10)	14	18	50	14	18
	380V	18 (14)	18	22	50	18	22
	220/250V	30 (25)	30	35	100	30	35
DC	500V(3P)	5	5	10	30	5	10
	250V(2P)	5	5	10	30	5	10
Service breaking capacity(%I _{cu}), I _{cs}		100	100	100	100	100	100
Category of use		A	A	A	A	A	A
Endurance (Number of operations)	Mechanical	25,000	25,000	25,000	25,000	25,000	25,000
	Electrical	10,000	10,000	10,000	10,000	10,000	10,000
Type of trip unit							
Thermal-magnetic release		fixed	fixed	fixed	fixed	fixed	fixed
Hydraulic-magnetic release		-	-	-	-	-	-
Magnetic release only without thermal trip							
Earth leakage protection	for 3 pole	▲	▲	▲	▲	▲	▲
Accessories							
Electrical auxiliaries	Auxiliary switch	●	●	●	●	●	●
	Alarm switch	●	●	●	●	●	●
	Shunt trip	●	●	●	●	●	●
	Undervoltage trip	●	●	●	●	●	●
External accessories	Direct rotary handle	●	●	●	●	●	●
	Extended rotary handle	●	●	●	●	●	●
	Terminal shield	●	●	●	●	●	●
	Insulation barrier	●	●	●	●	●	●
	Rear connection	●	●	●	●	●	●
	Pad handle lock	●	●	●	●	●	●
	Plug-in device	●	●	●	●	●	●
Dimensions (mm)	W×H×D (3P)	75×130×60	75×130×60		90×155×60	75×130×60	
Weight(kg)	2 pole	0.5	0.5	0.5	0.7	0.5	0.5
	3 pole	0.7	0.7	0.7	1	0.7	0.7
	4 pole	0.9	0.9	0.9	1.2	0.9	0.9

Note) 1. ● applicable or available
 2. ▲ available as a separate breaker
 3. The I_{cs}(service breaking capacity) of ABN100e, ABL125/250AF are in ()



100		125			250			
N-Type		S-Type	H-Type	L-Type	N-Type	S-Type	H-Type	L-Type
ABN102c	ABN102e	ABS102c	ABH102c	ABL102c	ABN202c	ABS202c	ABH202c	ABL202c
ABN103c	ABN103e	ABS103c	ABH103c	ABL103c	ABN203c	ABS203c	ABH203c	ABL203c
ABN104c	ABN104e	ABS104c	ABH104c	ABL104c	ABN204c	ABS204c	ABH204c	ABL204c
15, 20, 30, 40, 50, 60, 75, 100		15, 20, 30, 40, 50, 60, 75, 100, 125			100, 125, 150, 175, 200, 225, 250			
690		690	690	690	690	690	690	690
500		500	500	500	500	500	500	500
1000		1000	1000	1000	1000	1000	1000	1000
8		8	8	8	8	8	8	8
5	7.5 (5)	8	10	10 (10)	8	8	10	10 (10)
10	14 (10)	25	35	35 (35)	18	26	35	35 (35)
18	31 (18)	37	50	60 (50)	26	37	50	60 (50)
22	31 (22)	42	50	60 (50)	30	42	50	60 (50)
35	50 (35)	85	100	100 (100)	65	85	100	100 (100)
10	15 (10)	20	30	30 (30)	10	20	30	30 (30)
10	15 (10)	20	30	30 (30)	10	20	30	30 (30)
100	()	100	100	()	100	100	100	()
A	A	A	A	A	A	A	A	A
25,000	25,000	25,000	25,000	25,000	25,000	25,000	25,000	25,000
10,000	10,000	10,000	10,000	10,000	5,000	5,000	5,000	5,000
fixed	fixed	fixed	fixed	fixed	fixed	fixed	fixed	fixed
-	-	-	-	-	-	-	-	-
▲	▲	▲	▲	▲	▲	▲	▲	▲
●	●	●	●	●	●	●	●	●
●	●	●	●	●	●	●	●	●
●	●	●	●	●	●	●	●	●
●	●	●	●	●	●	●	●	●
●	●	●	●	●	●	●	●	●
●	●	●	●	●	●	●	●	●
●	●	●	●	●	●	●	●	●
●	●	●	●	●	●	●	●	●
●	●	●	●	●	●	●	●	●
●	●	●	●	●	●	●	●	●
●	●	●	●	●	●	●	●	●
●	●	●	●	●	●	●	●	●
●	●	●	●	●	●	●	●	●
●	●	●	●	●	●	●	●	●
75×130×60		90×155×60			105×165×60			
0.5	0.5	0.7	0.7	0.7	1.1	1.1	1.1	1.1
0.7	0.7	1	1	1	1.2	1.2	1.2	1.2
0.9	0.9	1.2	1.2	1.2	1.6	1.6	1.6	1.6

Calibrated for 40°C	Amb. Temp.	-5°C	0°C	10°C	20°C	25°C	30°C	35°C	40°C	45°C	50°C
	In=15 to 30	111.9%	111.3%	110.0%	108.0%	106.6%	104.9%	102.7%	100.0%	96.8%	93.3%
	In=40 to 100	110.2%	109.8%	108.7%	107.0%	105.8%	104.3%	102.4%	100.0%	97.2%	94.0%
	In=100 to 225	114.3%	113.2%	110.6%	107.5%	105.8%	104.0%	102.0%	100.0%	97.9%	95.6%
In=250 to 800	110.0%	109.0%	107.0%	105.0%	104.0%	103.0%	101.5%	100.0%	98.5%	97.0%	

Molded Case Circuit Breakers

Metasol 400AF to 1200AF Series

MCCB

Frame Size (AF)		400			
Type		N-Type	S-Type	H-Type	L-Type
Type and Pole	2 pole	ABN402c	ABS402c	ABH402c	ABL402c
	3 pole	ABN403c	ABS403c	ABH403c	ABL403c
	4 pole	ABN404c	ABS404c	ABH404c	ABL404c
Rated current, I _n	(A)	250, 300, 350, 400			
Rated operational voltage, U _e	AC(V)	690	690	690	690
	DC(V)	500	500	500	500
Rated insulation voltage, U _i	(V)	1000	1000	1000	1000
Rated impulse withstand voltage, U _{imp}	(kV)	8	8	8	8
Rated short-circuit breaking capacity(I _{cu}) kA (Sym), KSC8321, IEC 60947-2					
AC	690V	5	8	10	14
	480/500V	18	35	50	65
	415/460V	37	50	65	85
	380V	42	65	70	100
	220/250V	50	75	85	125
DC	500V(3P)	10	20	40	40
	250V(2P)	10	20	40	40
Service breaking capacity(%I _{cu}), I _{cs}		100	100	100	75
Category of use		A	A	A	A
Endurance (Number of operations)	Mechanical	4,000	4,000	4,000	4,000
	Electrical	1,000	1,000	1,000	1,000
Type of trip unit					
Thermal-magnetic release		fixed	fixed	fixed	fixed
Hydraulic-magnetic release		-	-	-	-
Magnetic release only without thermal trip		-	-	-	-
Earth leakage protection	for 3 pole	▲	▲	▲	▲
Accessories					
Electrical auxiliaries	Auxiliary switch	●	●	●	●
	Alarm switch	●	●	●	●
	Shunt trip	●	●	●	●
	Undervoltage trip	●	●	●	●
External accessories	Direct rotary handle	●	●	●	●
	Extended rotary handle	●	●	●	●
	Terminal shield	●	●	●	●
	Insulation barrier	●	●	●	●
	Rear connection	●	●	●	●
	Mechanical interlock	●	●	●	●
	Plug-in device	●	●	●	●
Dimensions (mm)	W×H×D (3P)	140×257×109			
Weight(kg)	2 pole	5.2	5.2	5.2	5.2
	3 pole	6.2	6.2	6.2	6.2
	4 pole	7.8	7.8	7.8	7.8

Note) 1. ● applicable or available
2. ▲ available as a separate breaker



800			1000		1200		
N-Type	S-Type	L-Type	S-Type	L-Type	S-Type		L-Type
ABN802c	ABS802c	ABL802c	-	-	-	-	-
ABN803c	ABS803c	ABL803c	ABS1003b	ABL1003b	ABS1203b	ABS1203bE	ABL1203b
ABN804c	ABS804c	ABL804c	ABS1004b	ABL1004b	ABS1204b	-	ABL1204b
500, 630, 700, 800			1000		1200		
690	690	690	600	600	600	600	600
500	500	500	-	-	-	-	-
1000	1000	1000	690	690	690	690	690
8	8	8	6	6	6	6	6
8	10	14	-	-	-	-	-
25	45	65	50	75	50	50	75
37	65	85	65	85	65	65	85
45	75	100	65	85	65	65	85
50	85	125	100	125	100	100	125
10	20	40	-	-	-	-	-
10	20	40	-	-	-	-	-
100	100	75	50	50	50	50	50
A	A	A	A	A	A	A	A
2,500	2,500	2,500	2,500	2,500	2,500	2,500	2,500
500	500	500	500	500	500	500	500
fixed	fixed	fixed	fixed	fixed	fixed	-	fixed
-	-	-	-	-	-	Adjustable	-
-	-	-	-	-	-	-	-
▲	▲	▲	-	-	-	●	-
●	●	●	●	●	●	●	●
●	●	●	●	●	●	●	●
●	●	●	●	●	●	●	●
●	●	●	-	-	-	-	-
●	●	●	-	-	-	-	-
●	●	●	-	-	-	-	-
●	●	●	●	●	●	●	●
●	●	●	●	●	●	●	●
●	●	●	-	-	-	-	-
●	●	●	-	-	-	-	-
210×280×109			220×400×105		220×400×105		
11	11	11	-	-	-	-	-
11.5	11.5	11.5	19.6	19.6	-	-	-
18.2	18.2	18.2	-	-	25.7	25.7	25.7

Calibrated for 40°C	Amb. Temp.	-5°C	0°C	10°C	20°C	25°C	30°C	35°C	40°C	45°C	50°C
	In=15 to 30	111.9%	111.3%	110.0%	108.0%	106.6%	104.9%	102.7%	100.0%	96.8%	93.3%
	In=40 to 100	110.2%	109.8%	108.7%	107.0%	105.8%	104.3%	102.4%	100.0%	97.2%	94.0%
	In=100 to 225	114.3%	113.2%	110.6%	107.5%	105.8%	104.0%	102.0%	100.0%	97.9%	95.6%
	In=250 to 800	110.0%	109.0%	107.0%	105.0%	104.0%	103.0%	101.5%	100.0%	98.5%	97.0%

Earth Leakage Circuit Breakers

Metasol 30AF to 250AF Series

ELCB

Frame Size (AF)		30	50		
Type		S-Type	N-Type	S-Type	H-Type
Type and pole	2-pole	EBS32c	EBN52c	-	-
	3-pole	EBS33c	EBN53c	EBS53c	EBH53c
	4-pole	EBS34c	-	EBS54c	EBH54c
Protective function		Overload, Short-circuit and ground fault	Overload, Short-circuit and ground fault		Overload, Short-circuit and ground fault
Rated current, I _n	(A)	(5, 10) ^{Note 2} , 15, 20, 30	15, 20, 30, 40, 50		15, 20, 30, 40, 50
Rated impulse withstand voltage, U _{imp}	(kV)	6	6		6
Instantaneous type	Rated residual current, I _{Δn}	(mA)	30, 100, 100/200/500 100/300/500	30, 100, 100/200/500, 100/300/500	30, 100, 100/200/500 100/300/500
	Residual current off-time at I _{Δn}	sec	≤ 0.1	≤ 0.1	≤ 0.1
Time delay type	Rated operational voltage, U _e	AC (V)	220/460	220/460	220/460
	Rated residual current	1A	0.1/0.2/0.5/1	0.1/0.2/0.5/1	0.1/0.2/0.5/1
	Intentional time delay	1s	0/0.2/0.5/1	0/0.2/0.5/1	0/0.2/0.5/1
	Rated residual current	2A	0.1/0.4/1/2	0.1/0.4/1/2	0.1/0.4/1/2
	Intentional time delay	2s	0.5/1/1.5/2	0.5/1/1.5/2	0.5/1/1.5/2
Rated short-circuit breaking capacity (I _{cu}) kA (Sym), KSC8321, IEC 60947-2					
AC	460V	14 (10)	14	18	50
	415V	14 (10)	14	18	50
	220/250V	30 (25)	30	35	100
Service breaking capacity(%I _{cu}), I _{cs}			100	100	100
Category of use			A	A	A
Endurance (Number of operations)	Mechanical		25,000	25,000	25,000
	Electrical		10,000	10,000	10,000
Type of trip unit					
Overcurrent pick-up			Thermal-magnetic	Thermal-magnetic	
Earth leakage pick-up			Electronic	Electronic	
Accessories					
Electrical auxiliaries	Auxiliary switch		●	●	●
	Alarm switch		●	●	●
External accessories	Insulation barrier		●	●	●
	Terminal cover (Long)		●	●	●
	Terminal cover (Short)		●	●	●
	Rotary handle (Direct)		●	●	●
	Rotary handle (Direct, Key lock)		●	●	●
	Rotary handle (Extended)		●	●	●
	Rear terminal (Bar)				●
	Rear terminal (Round)		●	●	●
	Pad handle lock		●	●	●
Dimensions (mm)	W×H×D (3P)	75×130×60	75×130×60		90×155×60
Weight(kg)	2 pole	-	0.5	-	-
	3 pole	0.7	0.7	0.7	1
	4 pole	0.9	-	0.9	1.2

Note) 1. ● applicable or available

2. The short-circuit breaking capacities in () are applied to the rated current in (5, 10A)



60		100	125		250		
N-Type	S-Type	N-Type	S-Type	H-Type	N-Type	S-Type	H-Type
-	-	EBN102c	-	-	EBN202c	-	-
EBN63c	EBS63c	EBN103c	EBS103c	EBH103c	EBN203c	EBS203c	EBH203c
-	EBS64c	EBN104c	EBS104c	EBH104c	-	EBS204c	EBH204c
Overload, Short-circuit and ground fault		Overload, Short-circuit and ground fault	Overload, Short-circuit and ground fault		Overload, Short-circuit and ground fault		
60		60, 75, 100	15, 20, 30, 40, 50, 60, 75, 100, 125		100, 125, 150, 175, 200, 225, 250		
6		6	6		6		
30, 100, 100/200/500, 100/300/500		30, 100, 100/200/500, 100/300/500	30, 100, 100/200/500, 100/300/500		30, 100, 100/200/500, 100/300/500		
≤ 0.1		≤ 0.1	≤ 0.1		≤ 0.1		
220/460		220/460	220/460		220/460		
0.1/0.2/0.5/1		0.1/0.2/0.5/1	0.1/0.2/0.5/1		0.1/0.2/0.5/1		
0/0.2/0.5/1		0/0.2/0.5/1	0/0.2/0.5/1		0/0.2/0.5/1		
0.1/0.4/1/2		0.1/0.4/1/2	0.1/0.4/1/2		0.1/0.4/1/2		
0.5/1/1.5/2		0.5/1/1.5/2	0.5/1/1.5/2		0.5/1/1.5/2		
14	18	18	37	50	26	37	50
14	18	18	37	50	26	37	50
30	35	35	85	100	65	85	100
100	100	100	100	100	100	100	100
A	A	A	A	A	A	A	A
25,000	25,000	25,000	25,000	25,000	20,000	20,000	20,000
10,000	10,000	10,000	10,000	10,000	5,000	5,000	5,000
Thermal-magnetic		Thermal-magnetic	Thermal-magnetic		Thermal-magnetic		
Electronic		Electronic	Electronic		Electronic		
•	•	•	•	•	•	•	•
•	•	•	•	•	•	•	•
•	•	•	•	•	•	•	•
•	•	•	•	•	•	•	•
•	•	•	•	•	•	•	•
•	•	•	•	•	•	•	•
•	•	•	•	•	•	•	•
•	•	•	•	•	•	•	•
•	•	•	•	•	•	•	•
•	•	•	•	•	•	•	•
•	•	•	•	•	•	•	•
75×130×60		75×130×60	90×155×60		105×165×60		
-	-	0.5	-	-	1.1	-	-
0.7	0.7	0.7	1	1	1.2	1.2	1.2
-	0.9	0.9	1.2	1.2	-	1.5	1.5

Earth Leakage Circuit Breakers

Metasol 400AF to 1200AF Series

ELCB

Frame Size (AF)			400			
Type			N-Type	S-Type	H-Type	L-Type
Type and pole	3-pole		EBN403c	EBS403c	EBH403c	EBL403c
	4-pole		EBN404c	EBS404c	EBH404c	EBL404c
Protective function			Overload, Short-circuit and ground fault			
Rated current, I _n	(A)		250, 300, 350, 400			
Rated impulse withstand voltage, U _{imp}	(kV)		6			
Rated operational voltage, U _e	AC (V)		220/460			
Instantaneous type	Rated residual current, I _{Δn}	(mA)	30, 100/200/500			
	Residual current off-time at I _{Δn}	sec	≤ 0.1	≤ 0.1	≤ 0.1	≤ 0.1
Time delay type	Rated residual current	A	0.1/0.4/1/2	0.1/0.4/1/2	0.1/0.4/1/2	0.1/0.4/1/2
	Intentional time delay	s	0.5/1/1.5/2	0.5/1/1.5/2	0.5/1/1.5/2	0.5/1/1.5/2
Rated short-circuit breaking capacity (I _{cu}) kA (Sym), KSC8321, IEC 60947-2						
AC	415/460V		37	50	65	85
	220/250V		50	75	85	125
Service breaking capacity(%I _{cu}), I _{cs}			100	100	100	100
Category of use			A	A	A	A
Endurance (Number of operations)	Mechanical		4,000	4,000	4,000	4,000
	Electrical		1,000	1,000	1,000	1,000
Type of trip unit						
Overcurrent pick-up			Thermal-magnetic			
Earth leakage pick-up			Electronic			
Accessories						
Electrical auxiliaries	Auxiliary switch		●	●	●	●
	Alarm switch		●	●	●	●
	Shunt trip		●	●	●	●
	Undervoltage trip		●	●	●	●
External accessories	Insulation barrier		●	●	●	●
	Terminal cover (Long) - 2, 3 pole		●	●	●	●
	Terminal cover (Long) - 4 pole		●	●	●	●
	Rotary handle (Direct)		●	●	●	●
	Rotary handle (Extended)		●	●	●	●
	Mechanical interlock - 2, 3 pole		●	●	●	●
	Mechanical interlock - 4 pole		●	●	●	●
	Rear terminal - 2 pole		●	●	●	●
	Rear terminal - 3 pole		●	●	●	●
Rear terminal - 4 pole		●	●	●	●	
Dimensions (mm)	W×H×D (3P)		140×257×109			
Weight(kg)	3 pole		7	7	7	7
	4 pole		8.4	8.4	7	7

Note) 1. ● applicable or available



800			1000	1200
N-Type	S-Type	L-Type	S-Type	S-Type
EBN803c	EBS803c	EBL803c	EBS1003b	EBS1203b
-	-	-	-	-
Overload, Short-circuit and ground fault			Overload, Short-circuit and Ground fault	
500, 630, 700, 800			1000	1200
6			-	-
220/460			220/460	220/460
30, 100/200/500			100/200/500	100/200/500
≤ 0.1	≤ 0.1	≤ 0.1	≤ 0.1	≤ 0.1
0.1/0.4/1/2	0.1/0.4/1/2	0.1/0.4/1/2	-	-
0.5/1/1.5/2	0.5/1/1.5/2	0.5/1/1.5/2	-	-
37	65	85	85	85
50	85	125	125	125
100	100	75	-	-
A	A	A	-	-
2,500	2,500	2,500	2,500	2,500
500	500	500	500	500
Thermal-magnetic			Thermal-magnetic	
Electronic			Electronic	
•	•	•	•	•
•	•	•	•	•
•	•	•	-	-
•	•	•	-	-
•	•	•	-	-
•	•	•	-	-
•	•	•	-	-
•	•	•	-	-
•	•	•	-	-
•	•	•	-	-
•	•	•	-	-
•	•	•	-	-
•	•	•	-	-
•	•	•	-	-
•	•	•	-	-
•	•	•	-	-
•	•	•	-	-
•	•	•	-	-
•	•	•	-	-
•	•	•	-	-
210×280×109			220×565×105	
11.5	11.5	11.5	27.1	27.1
-	-	-	-	-

Air Circuit Breakers

Susol ACB Series



Circuit Breaker

			AH-D					
Type			AH-06D	AH-08D	AH-10D	AH-13D	AH-16D	AH-20D
Ampere frame	(AF)		630	800	1000	1250	1600	2000
Rated current (A)	(In max)	at 40°C	200, 400, 630	200, 400, 630, 800	630, 800, 1000	630, 800, 1000, 1250	800, 1000, 1250, 1600	1000, 1250, 1600, 2000
Setting current (A)*	Control trip relay (... × In max)		0.4 ~ 1.0					
Rated current of neutral pole (A)			630	800	1000	1250	1600	2000
Rated insulation voltage (V)	(Ui)		1,000					
Rated operational voltage (V)	(Ue)		690					
Rated impulse withstand voltage (kV) (Uimp)			12					
Frequency (Hz)			50/60					
Number of poles (P)			3/4					
Rated breaking capacity (kA sym)			220V/230V/380V/415V					
AC 50/60Hz	(Icu)	IEC 60947-2 KS C 4620	460V/480V/500V			85		
			550V/600V/690V			85		
Rated service breaking capacity (kA) (Ics)			... %×Icu			65		
Rated making capacity (kA peak)			220V/230V/380V/415V					
AC 50/60Hz	(Icm)	IEC 60947-2 KS C 4620	460V/480V/500V			187		
			550V/600V/690V			187		
Rated short-time withstand current (kA)	(Icw)		1 sec		65			
			2 sec		60			
			3 sec		50			
Operating time (ms)			Maximum total breaking time		Less than 25ms under Icw/Less than 75ms over Icw			
			Maximum closing time		80ms under			
Life cycle (time)	Mechanical		20,000					
	Electrical		5,000					
Connections**	Draw-out / Fixed		Horizontal connection		●		-	
			Vertical connection		○		●	
			Front connection		○		-	
			Mixed connection		○		-	
Weight (kg) (3P/4P)	Draw-out type	Main body	Motor charging type		63/74		70/85	
		(With cradle)	Manual charging type		61/72		68/83	
		Cradle only			29/32		33/40	
	Fixed type		Motor charging type		34/44		38/47	
			Manual charging type		32/42		36/45	
External dimensions (mm) (H×W×D)		Draw-out type	3P	430×334×375				
		4P	430×419×375					
		Fixed type	3P	300×300×295				
		4P	300×385×295					
Trip relay			N, A, P, S type					
Certificate & Approval			KS / KEMA / KERI / GOST / CCC					
Marine classification			LR, ABS, DNV, KR, BV, GL, RINA, NK					

* Refer to trip relay specification. ** ●: Standard, ○: Option

Note) 1. Life time does not mean guarantee, but limitation.

Quality guarantee: On/Off frequency on the basis of IEC60947-2 within the term of guarantee

2. In case of Marine ACB, please contact us.

3. The use of AN-D, AS-D, AH-D and AS-F in IT systems is limited to 500 V network voltage.

4. AH-20D, AH-40E types are equipped with vertical-only terminals.



AH-E									AH-G		
AH-06E	AH-08E	AH-10E	AH-13E	AH-16E	AH-20E	AH-25E	AH-32E	AH-40E	AH-40G	AH-50G	AH-63G
630	800	1000	1250	1600	2000	2500	3200	4000	4000	5000	6300
400, 630	400, 630, 800, (800)	630, 800, 1000	630, 800, 1000, 1250	800, 1000, 1250, 1600, (1600)	1000, 1250, 1600, 2000	1250, 1600, 2000, 2500	1600, 2000, 2500, 3200	2000, 2500, 3200, 4000, (3200)	2000, 2500, 3200, 4000	2500, 3200, 4000, 5000	3200, 4000, 5000, 6300
0.4 ~ 1.0											
630	800	1000	1250	1600	2000	2500	3200	4000	4000	5000	6300
1,000									1,000		
690									690		
12									12		
50/60									50/60		
3/4									3/4		
100									150		
100									150		
85									100		
100%									100%		
220									330		
220									330		
187									220		
85									100		
75									85		
65									75		
Less than 25ms under Icw/Less than 75ms over Icw									Less than 25ms under Icw/Less than 75ms over Icw		
80ms under									90ms under		
15,000									10,000		
5,000									2,000		
●									○		
○									●		
○									-		
○									-		
87/103									181/223		186/230
85/101									179/221		184/228
44/55									97/117		102/124
44/55									98/123		103/130
42/53									96/121		101/128
430×412×375									460×785×375		
430×527×375									460×1015×375		
300×378×295									300×751×295		
300×493×295									300×981×295		
N, A, P, S type									N, A, P, S type		
KS / KEMA / KERI / GOST / CCC									KS / KEMA / KERI / GOST / CCC		
LR, ABS, DNV, KR, BV, GL, RINA, NK									LR, ABS, DNV, KR, BV, GL, RINA, NK		

※ Derating of the rated current is required according to the ambient temperature around the breaker in a panel if it is higher than the reference value.

※ It is possible to connect power and load side reversely, but please use it for normal connection for maintenance and safety.

Air Circuit Breakers

Susol ACB Series



Switch-Disconnecter

			DH-D					
			DH-06D	DH-08D	DH-10D	DH-13D	DH-16D	DH-20D
Type			630	800	1000	1250	1600	2000
Ampere frame	(AF)		200, 400, 630	200, 400, 630, 800	630, 800, 1000	630, 800, 1000, 1250	800, 1000, 1250, 1600	1000, 1250, 1600, 2000
Rated current (A)	(In max)	at 40°C	0.4 ~ 1.0					
Setting current (A)*	Control trip relay (... × In max)		630	800	1000	1250	1600	2000
Rated current of neutral pole (A)			1,000					
Rated insulation voltage (V)	(Ui)		690					
Rated operational voltage (V)	(Ue)		12					
Rated impulse withstand voltage (kV) (Uimp)			50/60					
Frequency (Hz)			3/4					
Number of poles (P)			143					
Rated making capacity (kA peak)	(Icm)	IEC 60947-2 AC ~ 690V	65					
Rated short-time withstand current (kA)	(Icw)		60					
			50					
Operating time (ms)			Less than 25ms under Icw/Less than 75ms over Icw					
			80ms under					
Life cycle (time)	Mechanical		20,000					
	Electrical		5,000					
Connections**	Draw-out / Fixed		●					
		Horizontal connection	○					
		Vertical connection	○					
		Front connection	○					
		Mixed connection	○					
Weight (kg)	Draw-out type	Main body	63/74					
(3P/4P)		(With cradle)	61/72					
		Cradle only	29/32					
	Fixed type		34/44					
		Motor charging type	32/42					
		Manual charging type	70/85					
			68/83					
			33/40					
			38/47					
			36/45					
External dimensions (mm)		Draw-out type	430 × 334 × 375					
(H×W×D)		type	430 × 419 × 375					
		Fixed type	300 × 300 × 295					
			300 × 385 × 295					

* Refer to trip relay specification. ** ●: Standard, ○: Option
 Note) 1. Life time does not mean guarantee, but limitation.

- Quality guarantee: On/Off frequency on the basis of IEC60947-3 within the term of guarantee
 2. In case of Marine ACB, please contact us.
 3. DH-20D, DH-40E types are equipped with vertical-only terminals.



DH-E								
DH-06E	DH-08E	DH-10E	DH-13E	DH-16E	DH-20E	DH-25E	DH-32E	DH-40E
630	800	1000	1250	1600	2000	2500	3200	4000
400, 630	400, 630, 800, (800)	630, 800, 1000	630, 800, 1000, 1250	800, 1000, 1250, 1600, (1600)	1000, 1250, 1600, 2000	1250, 1600, 2000, 2500	1600, 2000, 2500, 3200	2000, 2500, 3200, 4000, (3200)
0.4 ~ 1.0								
630	800	1000	1250	1600	2000	2500	3200	4000
1,000								
690								
12								
50/60								
3/4								
187								
85								
75								
65								
Less than 25ms under Icw/Less than 75ms over Icw								
80ms under								
15,000								
5,000								
●								
○								
○								
○								
87/103								
85/101								
44/55								
44/55								
42/53								
430×412×375								
430×527×375								
300×378×295								
300×493×295								

※ Derating of the rated current is required according to the ambient temperature around the breaker in a panel if it is higher than the reference value.

Air Circuit Breakers

Metasol ACB Series



Circuit Breaker

				AN-D					
Type				AN-06D	AN-08D	AN-10D	AN-13D	AN-16D	
Ampere frame	(AF)			630	800	1000	1250	1600	
Rated current (A)	(In max)	at 40°C		200, 400, 630	200, 400, 630, 800	630, 800, 1000	630, 800, 1000, 1250	800, 1000, 1250, 1600	
Setting current (A)*	Control trip relay (... × In max)			0.4 ~ 1.0					
Rated current of neutral pole (A)				630	800	1000	1250	1600	
Rated insulation voltage (V)	(Ui)			1,000					
Rated operational voltage (V)	(Ue)			690					
Rated impulse withstand voltage (kV)	(Uimp)			12					
Frequency (Hz)				50/60					
Number of poles (P)				3/4					
Rated breaking capacity (kA sym)				65					
AC 50/60Hz	(Icu)	IEC 60947-2 KS C 4620	220V/230V/380V/415V 460V/480V/500V 550V/600V/690V	65 65 50					
Rated service breaking capacity (kA)	(Ics)	... %×Icu		100%					
Rated making capacity (kA peak)				143					
AC 50/60Hz	(Icm)	IEC 60947-2 KS C 4620	220V/230V/380V/415V 460V/480V/500V 550V/600V/690V	143 105					
Rated short-time withstand current (kA)	(Icw)	1 sec 2 sec 3 sec		50 42 36					
Operating time (ms)			Maximum total breaking time	Less than 25ms under Icw/Less than 75ms over Icw					
			Maximum closing time	80ms under					
Life cycle (time)	Mechanical				20,000				
	Electrical				5,000				
Connections**	Draw-out / Fixed	Horizontal connection		●					
			Vertical connection	○					
			Front connection	○					
			Mixed connection	○					
Weight (kg)	Draw-out type	Main body	Motor charging type	63/74					
(3P/4P)	(With cradle)		Manual charging type	61/72					
	Cradle only				29/32				
	Fixed type	Motor charging type		34/44					
			Manual charging type	32/42					
External dimensions (mm)	Draw-out		3P	43 × 334 × 375					
(H×W×D)	type		4P	430 × 419 × 375					
	Fixed type		3P	300 × 300 × 295					
			4P	300 × 385 × 295					
Trip relay					N, A, P, S type				
Certificate & Approval					KS / KEMA / KERI / GOST				
Marine classification					-				

* Refer to trip relay specification. ** ●: Standard, ○: Option
 Note) 1. Life time does not mean guarantee, but limitation.

- Quality guarantee: On/Off frequency on the basis of IEC60947-2 within the term of guarantee
 2. The use of AN-D, AS-D and AS-F in IT systems is limited to 500 V network voltage.
 3. AS-20D, AS-40E types are equipped with vertical-only terminals.



AS-D						AS-E				AS-F		AS-G			
AS-06D	AS-08D	AS-10D	AS-13D	AS-16D	AS-20D	AS-20E	AS-25E	AS-32E	AS-40E	AS-40F	AS-50F	AS-40G	AS-50G	AS-63G	
630	800	1000	1250	1600	2000	2000	2500	3200	4000	4000	5000	4000	5000	6300	
200, 400, 630	200, 400, 630, 800	630, 800, 1000	630, 800, 1000, 1250	800, 1000, 1250, 1600	1000, 1250, 1600, 2000	630, 800, 1000, 1250, 1600, 2000	1250, 1600, 2000, 2500, 3200	1600, 2000, 2500, 3200	2000, 2500, 3200, 4000	2000, 2500, 3200, 4000, (3200, 4000)	2500, 3200, 4000, 5000	2000, 2500, 3200, 4000	2500, 3200, 4000, 5000	3200, 4000, 5000, 6300	
0.4 ~ 1.0						0.4 ~ 1.0				0.4 ~ 1.0		0.4 ~ 1.0			
630	800	1000	1250	1600	2000	2000	2500	3200	4000	4000	5000	4000	5000	6300	
1,000						1,000				1,000		1,000			
690						690				690		690			
12						12				12		12			
50/60						50/60				50/60		50/60			
3/4						3/4				3/4		3/4			
70						85				100		120			
70						85				100		120			
65						85				85		100			
100%						100%				100%		100%			
154						187				220		264			
154						187				220		264			
143						187				187		220			
65						85				85		100			
50						75				75		85			
42						65				65		75			
Less than 25ms under Icw/Less than 75ms over Icw						Less than 25ms under Icw/Less than 75ms over Icw				Less than 25ms under Icw/Less than 75ms over Icw					
80ms under						80ms under				90ms under		90ms under			
20,000						15,000				10,000		10,000			
5,000						5,000				2,000		2,000			
●						●				○		○			
○						○				●		●			
○						○				-		-			
○						○				-		-			
63/74			70/85			87/103		104/147		107/139		181/223		186/230	
61/72			63/83			85/101		102/145		102/145		179/221		184/228	
29/32			33/40			44/50		58/70		65/85		97/117		102/124	
34/44			38/47			44/55		63/100		61/81		98/123		103/130	
32/42			36/45			42/53		61/98		60/80		96/121		101/128	
430×334×375						430×412×375				460×629×375		460×785×375			
430×419×375						430×527×375				460×799×375		460×1015×375			
300×300×295						300×378×295				300×597×295		300×751×295			
300×385×295						300×493×295				300×767×295		300×981×295			
N, A, P, S type						N, A, P, S type				N, A, P, S type		N, A, P, S type			
KS / KEMA / KERI / GOST						KS / KEMA / KERI / GOST				KS / KEMA / KERI / GOST					
LR, ABS, DNV, KR, BV, GL, RINA, NK						LR, ABS, DNV, KR, BV, GL, RINA, NK				LR, ABS, DNV, KR, BV, GL, RINA, NK					

※ Derating of the rated current is required according to the ambient temperature around the breaker in a panel if it is higher than the reference value.
 ※ It is possible to connect power and load side reversely, but please use it for normal connection for maintenance and safety.

Air Circuit Breakers

Metasol ACB Series



Switch-Disconnecter

			DN-D				
Type			DN-06D	DN-08D	DN-10D	DN-13D	DN-16D
Ampere frame	(AF)		630	800	1000	1250	1600
Rated current (A)	(In max)	at 40°C	200, 400, 630	400, 630, 800	630, 800, 1000	630, 800, 1000, 1250	800, 1000, 1250, 1600
Setting current	(A)	Control trip relay (... × In max)	0.4~1.0				
Rated current of neutral pole	(A)		630	800	1000	1250	1600
Rated insulation voltage (V)	(Ui)		1000				
Rated operational voltage (V)	(Ue)		690				
Rated impulse withstand voltage (kV)	(Uimp)		12				
Frequency (Hz)			50/60				
Number of poles (P)			3/4				
Rated making capacity (kA peak)	(Icm)	IEC 60947-3 AC 690V / 600V / 550V	105				
Rated short-time withstand current (kA)	(Icw)	1 sec	50				
		2 sec	42				
		3 sec	36				
Operating time (ms)		Total breaking time	Less than 25ms under Icw/Less than 75ms over Icw				
		Closing time	80ms under				
Life cycle (time)		Mechanical	20000				
		Electrical	5000				
Connections	Draw-out type/ Fixed type	Horizontal connection	●				
		Vertical connection	○				
		Front connection	○				
		Mixed connection	○				
Weight (kg) (3P/4P)	Draw-out type	Main body	63/74				
		Motor charging type	61/72				
		Manual charging type	29/32				
	Fixed type	Motor charging type	34/44				
		Manual charging type	32/42				
External dimensions (mm) (H×W×D)		Draw-out type	3P	430×334×375			
			4P	430×419×375			
		Fixed type	3P	300×300×295			
			4P	300×385×295			

Note) 1. Life time does not mean guarantee, but limitation.
 Quality guarantee: On/Off frequency on the basis of IEC60947-3 within the term of guarantee
 2. DS-20D, DS-40E types are equipped with vertical-only terminals.



DS-D					
DS-06D	DS-08D	DS-10D	DS-13D	DS-16D	DS-20D
630	800	1000	1250	1600	2000
200, 400, 630	400, 630, 800	630, 800, 1000	630, 800, 1000, 1250	800, 1000, 1250, 1600	1000, 1250, 1600, 2000
0.4~1.0					
630	800	1000	1250	1600	2000
1000					
690					
12					
50/60					
3/4					
143					
65					
50					
42					
Less than 25ms under Icw/Less than 75ms over Icw					
80ms under					
20000					
5000					
●					-
○					●
○					-
○					-
63/74			70/85		
61/72			68/83		
29/32			33/40		
34/44			38/47		
32/42			36/45		
430×334×375					
430×419×375					
300×300×295					
300×385×295					

DS-E			
DS-20E	DS-25E	DS-32E	DS-40E
2000	2500	3200	4000
400, 630, 800, 1000, 1250, 1600, 2000	1250, 1600, 2000, 2500	1600, 2000, 2500, 3200	2000, 2500, 3200, 4000
0.4~1.0			
630, 800, 1000, 1250, 1600, 2000	2500	3200	4000
1000			
690			
12			
50/60			
3/4			
187			
85			
75			
65			
Less than 25ms under Icw/Less than 75ms over Icw			
80ms under			
15000			
5000			
●		-	
○		●	
○		-	
○		-	
87/103		107/139	
85/101		102/145	
44/50		65/85	
44/55		61/81	
42/53		60/80	
430×412×375			
430×527×375			
300×378×295			
300×493×295			

※ Derating of the rated current is required according to the ambient temperature around the breaker in a panel if it is higher than the reference value.

Air Circuit Breakers

Trip relay

The trip relay of Susol ACB provides the additional protection functions for voltage, frequency, unbalance, and others in addition to main protection functions for over current, short-circuit, ground fault. It supports the advanced measurement functions for voltage, current, power, electric energy, harmonics, communication function, and others.

Analog trip function interlocked with mechanism enhanced a durability of devices as well as the breaking capacity of ACB.

Zone selective interlocking function makes the protective coordination more simple and thermal memory can be applied to various loads.



Trip relay types



- L/S/I/G
- Self Power
- RTC Timer mounted
- Fault indicator (LED)
- NFC

- L/S/I/G (or Gext)
- ZSI (Protective coordination)
- Remote Reset
- ERMS, Local/Remote DI (Selectable)

- Modbus/RS-485
- USB Terminal (Power, Communication)
- Ethernet (Optional product required)
- Self Power
- AC/DC 24~48V, 100~250V
- RTC Timer mounter
- Fault Recording(127EA)
- Fault Wave Recording (6EA)
- DC 24 ~ 48V

- L(N)/S1/I/G(or Gext)
- Thermal(linear hot start)
- UV1/OV1/RV/D/S(V)1/VU/IU
- UF1/OF1/ROCOF/RP/RQ1/OP/OQ/UP
- Measurement: V/A/W/Wh/F/PF
- ZSI (Protective coordination)
- Remote Reset
- ERMS , Local/Remote DI (selectable)

- USB Terminal (Power, Communication)
- Modbus/RS-485
- Bluetooth (Option)
- Ethernet (Optional product required)

- Self Power
- AC/DC 24~48V, 100~250V
- RTC Timer mounted
- Event Recording (255EA)
- Fault Recording (127EA)
- Fault Wave (6EA)
- DC 24 ~ 48V

- L(N)/S(1,2)/I/G(or Gext)
- Thermal (linear hot start)
- UV(1,2)/OV(1,2)/RV/D/S(V)(1,2)/VU/IU
- UF(1,2)/OF(1,2)/ROCOF/RP/RQ(1,2)/OP/OQ/UP
- Measurement: V/A/W/Wh/F/PF
- Relay Group control (A,B)
- ZSI(Protective coordination)
- Remote Reset
- ERMS, Local/Remote, Group A/B DI (selectable)

- USB Terminal (Power, Communication)
- Modbus/RS-485
- Bluetooth
- Ethernet (Optional product required)
- NFC

- Self Power
- AC/DC 24~48V, 100~250V
- RTC Timer mounted
- Event Recording (255EA)
- Fault Recording (127EA)
- Fault Wave (6EA)
- DC 24 ~ 48V

LS Final Distribution Boards

LS Final Distribution Boards is fully type-tested by ASTA and specially designed for residential and commercial area for the protection of people and equipment.



شركة أبوظبي للتوزيع
Abu Dhabi Distribution Co.



Full range of Residential & Commercial Distribution System



Features:

- Designed to provide higher level of safety for final distribution board
- Pan assembly type busbar systems to provide easier cabling
- Split neutral bars provide easy connection and maximum cable space
- Easy and safe mounting of LS Miniature Circuit Breaker
- Flush and surface mounted
- Tin plate and cooper busbar
- Galvanized 1.2mm steel sheet



Technical Description

- In compliance with standards : IEC 60439-3
- Short-circuit withstand: 17kA/0.2s
- Peak short time withstand: 35kA
- Index of degree: IP 4X
- Rated operational Voltage(Ue): 415V
- Rated insulation Voltage(Ui): 460V
- Rated Frequency: 50/60Hz
- Rated impuls withstand Voltage(Uimp): 4kV
- Rated Current (In): Upto 125A

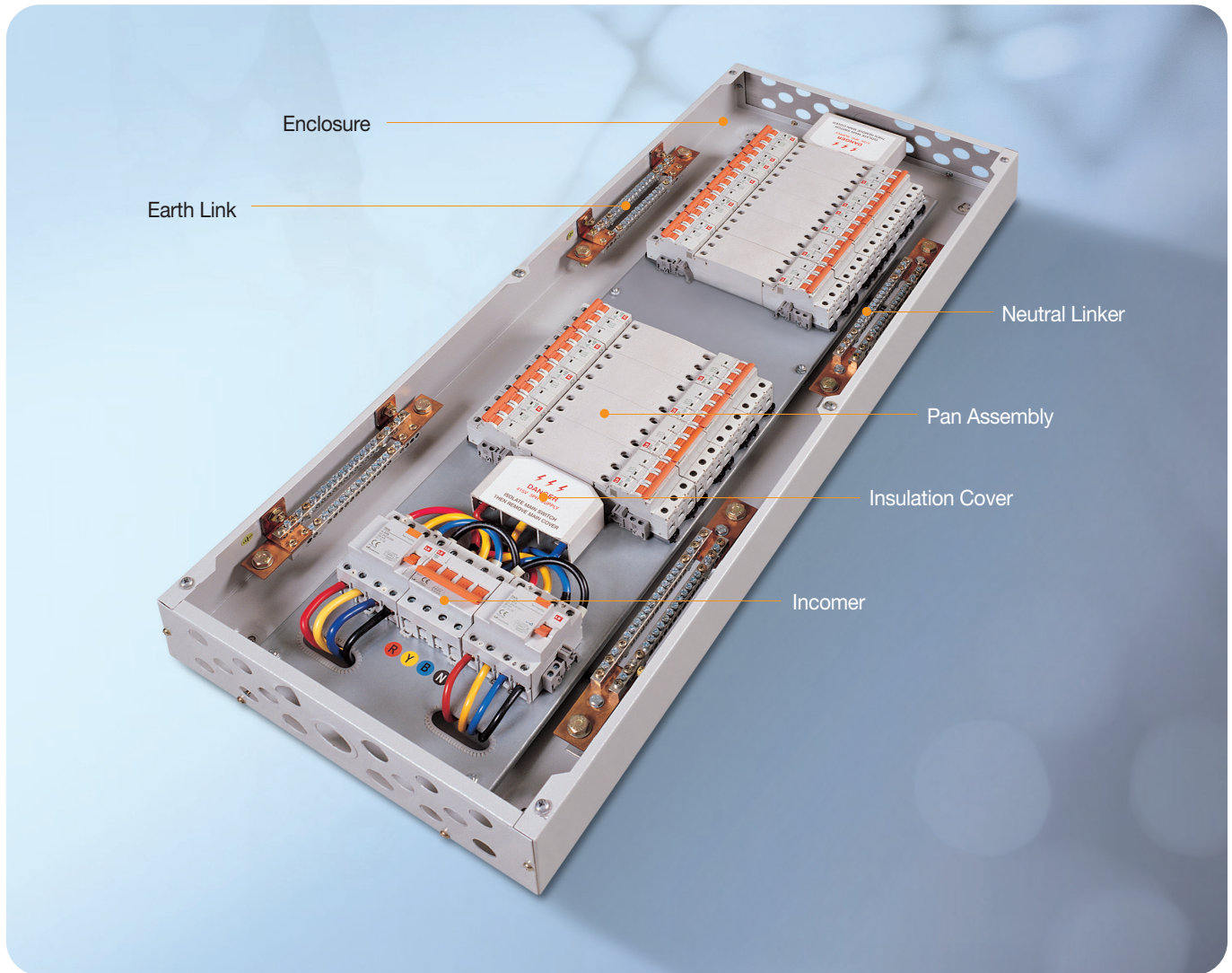

Pan Assembly System



- Rigid and removable pan assembly to provide easier cabling
- Modular panel system
- Flexible connect with CB, RCCB and Disconnect switch

LS Final Distribution Boards

Specific of FDB (Split busbar type)

with incoming Isolator feeding two ELCBs

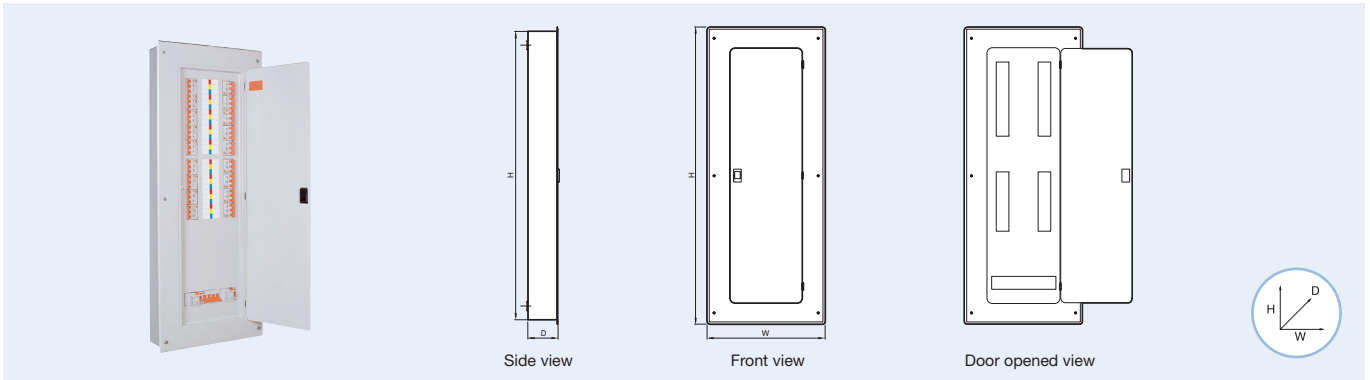

Selection of Enclosure

Code Description	Type	Dimension	
02+02 Way Split DB	Flush	530H×430W×110D mm	
04+02 Way Split DB		580H×430W×110D mm	
04+04 Way Split DB		680H×430W×110D mm	
06+04 Way Split DB		780H×430W×110D mm	
06+06 Way Split DB		780H×430W×110D mm	
08+06 Way Split DB		830H×430W×110D mm	
08+08 Way Split DB		980H×430W×110D mm	
10+08 Way Split DB		980H×430W×110D mm	
12+06 Way Split DB		980H×430W×110D mm	
02+02 Way Split DB		Surface	510H×410W×110D mm
04+02 Way Split DB			560H×410W×110D mm
04+04 Way Split DB			660H×410W×110D mm
06+04 Way Split DB	760H×410W×110D mm		
06+06 Way Split DB	760H×410W×110D mm		
08+06 Way Split DB	810H×410W×110D mm		
08+08 Way Split DB	960H×410W×110D mm		
10+08 Way Split DB	960H×410W×110D mm		
12+06 Way Split DB	960H×410W×110D mm		

Single busbar & Single Incomer type

With Incoming 4P ELCB/MCB/Isolator

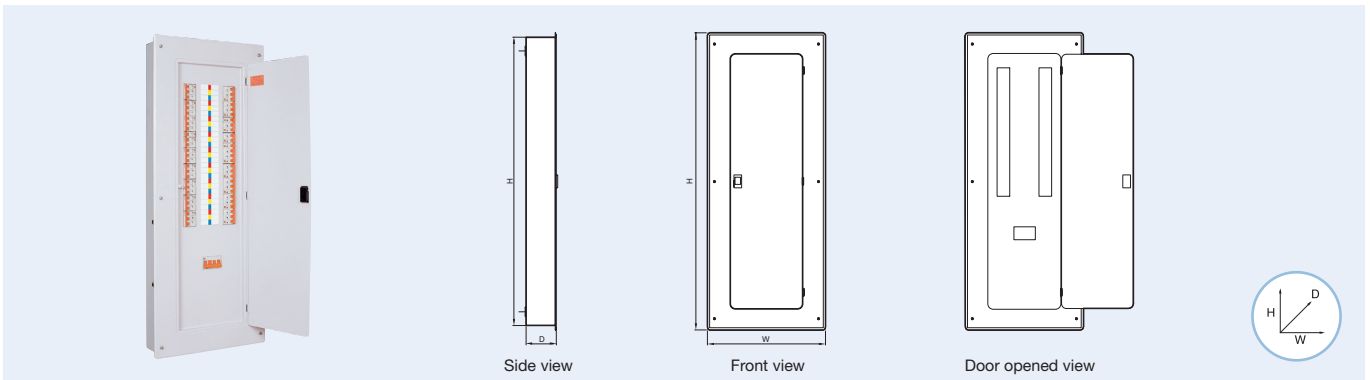

Selection of Enclosure

Code Description	Type	Dimension	
4 Way DB 1 INC	Flush	530H×430W×110D mm	
6 Way DB 1 INC		580H×430W×110D mm	
8 Way DB 1 INC		680H×430W×110D mm	
12 Way DB 1 INC		780H×430W×110D mm	
14 Way DB 1 INC		830H×430W×110D mm	
18 Way DB 1 INC		980H×430W×110D mm	
20 Way DB 1 INC		Customized available	
24 Way DB 1 INC		Customized available	
4 Way DB 1 INC		Surface	510H×410W×110 D mm
6 Way DB 1 INC			560H×410W×110 D mm
8 Way DB 1 INC	660H×410W×110 D mm		
12 Way DB 1 INC	760H×410W×110 D mm		
14 Way DB 1 INC	810H×410W×110 D mm		
18 Way DB 1 INC	960H×410W×110 D mm		
20 Way DB 1 INC	Customized available		
24 Way DB 1 INC	Customized available		

Specific of FDB (Single busbar & Dual Incomer type)

With Incoming Isolator & ELCB

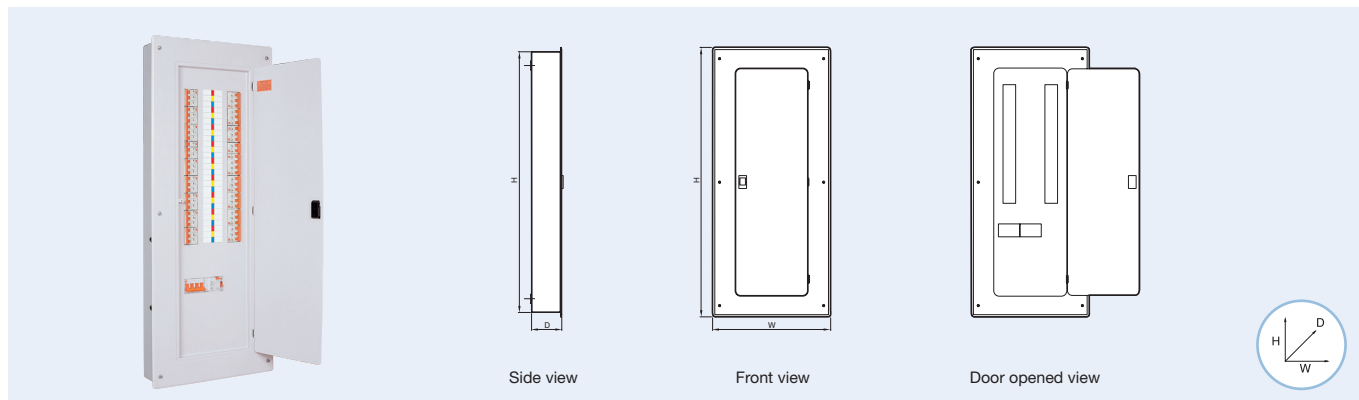

Selection of Enclosure

Code Description	Type	Dimension
4 Way DB 2 INC	Flush	530H×430W×110D mm
6 Way DB 2 INC		580H×430W×110D mm
8 Way DB 2 INC		680H×430W×110D mm
12 Way DB 2 INC		780H×430W×110D mm
14 Way DB 2 INC		830H×430W×110D mm
18 Way DB 2 INC		980H×430W×110D mm
20 Way DB 2 INC	Surface	Customized available
24 Way DB 2 INC		Customized available
4 Way DB 2 INC		510H×410W×110D mm
6 Way DB 2 INC		560H×410W×110D mm
8 Way DB 2 INC		660H×410W×110D mm
12 Way DB 2 INC		760H×410W×110D mm
14 Way DB 2 INC		810H×410W×110D mm
18 Way DB 2 INC		960H×410W×110D mm
20 Way DB 2 INC	Customized available	
24 Way DB 2 INC	Customized available	

SP&N Consumer Unit

Incoming 2P ELCB / MCB / Isolator

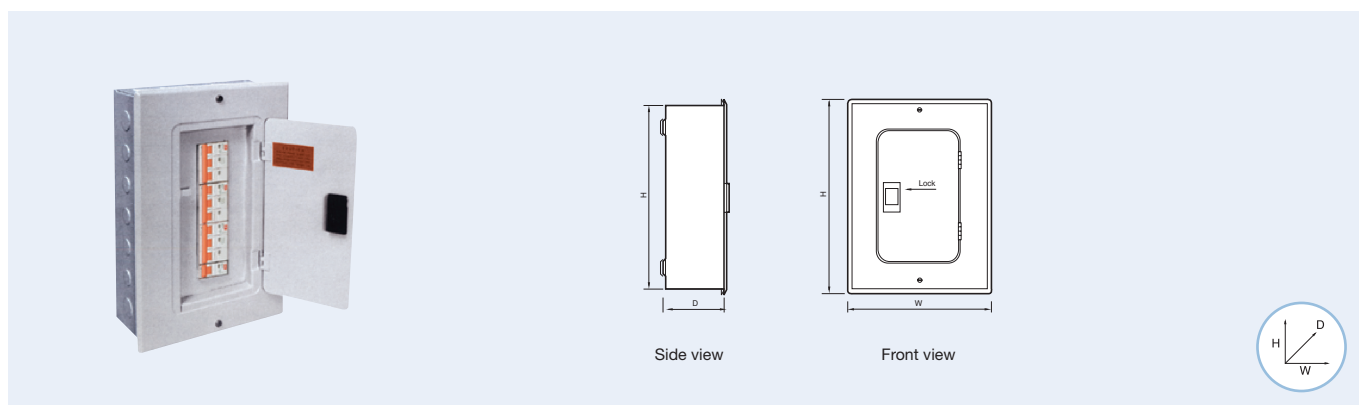

Selection of Enclosure

Code Description	Type	Dimension
6 Way 1P C.Unit		320H×240W×100D mm
9 Way 1P C.Unit		370H×240W×100D mm
12 Way 1P C.Unit		420H×250W×100D mm
15 Way 1P C.Unit		490H×250W×100D mm
18 Way 1P C.Unit		550H×250W×100D mm
22 Way 1P C.Unit		Customized available

LS SMDB Solution

- LS SMDB Solutions are arranged for 3 Phase and neutral incoming supply and specially designed easy to install MCCBs.
- These are fitted with Form 3b and 2 busbar assemblies, tested and ASTA Certified.



شركة أبوظبي للتوزيع
Abu Dhabi Distribution Co.



Rating

- A wide choice of incoming MCCBs make LS SMDB panels flexible to suit most of the requirements and represent excellent value and will appeal to consultants, contractors, end users and OEMs. These are offered in ratings of 125A, 250A, 400A, 630A.
- All incoming and outgoing MCCBs have Thermal/Magnetic fixed and adjustable tripping mechanisms incorporated with a trip-to-test button. These are available in ratings as follows : 16, 20, 25, 32, 40, 50, 63, 80, 100, 125, 160, 250, 400, 630A.

Technical Specifications

Constructional Characteristics

- Complied with IEC 60947-1
- Fully Type Tested, ASTA Certified
- Degree of protection : IP41 as per IEC 60529
- Form of separation: Form 3b
- Enclosure constructed from rigid folded zinc phosphate and protected both internally and externally with polyester powder coating

Electrical Characteristics

- Rated Operational Voltage U_e : upto 690V
- Rated Insulation voltage U_i : upto 750V
- Rated Frequency: 50/60Hz
- Rated Impulse withstand voltage U_{imp} : 8kV
- Rated Short time I_{cw} & peak withstand I_{pk} Current: 36kA/1S

Incoming Devices (MCCB Panelboards)

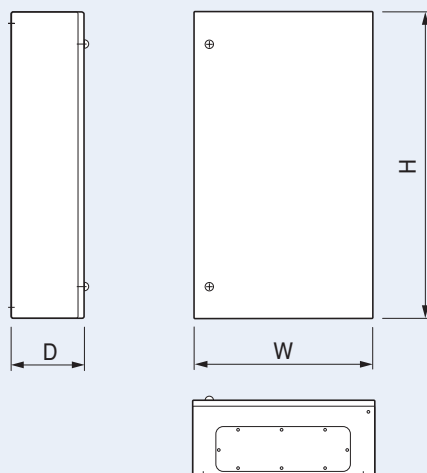

Metasol Series

Incoming Breaker 250 Amps Outgoing Breaker 100 Amps				Incoming Breaker 400 Amps Outgoing Breaker 100 Amps				Incoming Breaker 630 Amps Outgoing Breaker 100 Amps			
No of Ways	Width	Height	Depth	No of Ways	Width	Height	Depth	No of Ways	Width	Height	Depth
2	700	800	180	4	700	1000	250				
4	700	800	180	6	700	1000	250	6	800	1000	250
6	700	800	180	8	700	1200	250	8	800	1200	250
8	700	1000	180	10	700	1400	250	10	800	1400	250
10	700	1200	180	12	700	1400	250	12	800	1400	250
12	700	1200	180	14	700	1600	250	14	800	1600	250

Susol TD/TS Series

Incoming Breaker 250 Amps Outgoing Breaker 100 Amps				Incoming Breaker 400 Amps Outgoing Breaker 100 Amps				Incoming Breaker 630 Amps Outgoing Breaker 100 Amps			
No of Ways	Width	Height	Depth	No of Ways	Width	Height	Depth	No of Ways	Width	Height	Depth
2	700	800	180	4	700	1000	250				
4	700	800	180	6	700	1000	250	6	800	1000	250
6	700	800	180	8	700	1200	250	8	800	1200	250
8	700	1000	180	10	700	1400	250	10	800	1400	250
10	700	1200	180	12	700	1400	250	12	800	1400	250
12	700	1200	180	14	700	1600	250	14	800	1600	250

LS SMDB Solution

Incoming Devices

LS “Susol series” range of MCCBs

Rated current, In	250A 630A								
Rated operational voltage, Ue	750V								
MCCB breaker type	TS250			TS400			TS630		
Ultimate breaking capacity, Icu (kA rms) at 415V	N	H	L	N	H	L	N	H	L
	50	85	150	50	85	150	50	85	150
Service breaking capacity, Ics.....% Icu	100% Icu			100% Icu			100% Icu		
Protection trip unit	Thermal magnetic / Electronic								
Switch disconnecter type TS	TS250NA			TS400NA			TS630NA		
Short-circuit making capacity Icm (kApeak) (with upstream circuit breaker)	4.9			7.1			8.5		

Incoming application

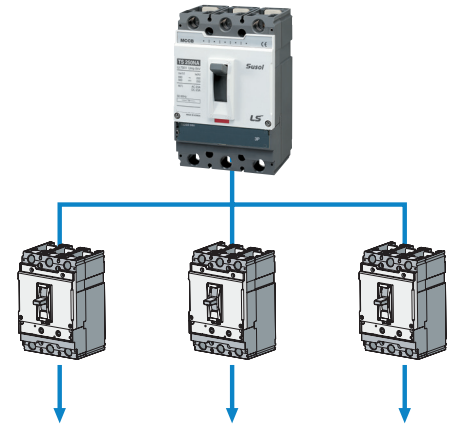

LS “Metasol series” range of MCCBs

Rated current, In	250A 630A		
Rated operational voltage, Ue	690V		
Breaker type	ABS203c	ABS403c	ABS803c
Ultimate breaking capacity, Icu (kA rms) at 415V	37	50	65
Service breaking capacity, Ics.....% Icu	100% Icu	100% Icu	100% Icu
Protection trip unit	Thermal magnetic		

Incoming application

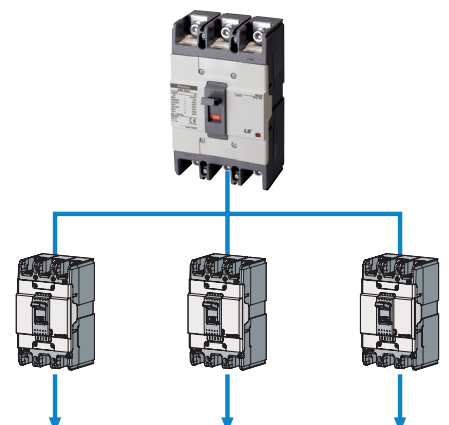

Outgoing devices

LS “Susol series” range of MCCBs

Rated current, In	16A 250A					
Rated operational voltage, Ue	upto 750V					
Breaker type	TD100, TD160, TS100, TS160, TS250					
	N		H		L	
No. of poles	1P	3P	1P	3P	1P	3P
Ultimate breaking capacity, Icu (kA rms) at 240V	30	100	50	120	-	200
Service breaking capacity, Ics.....% Icu	100% Icu					
Protection trip unit	Thermal magnetic / Electronic					

Incoming application

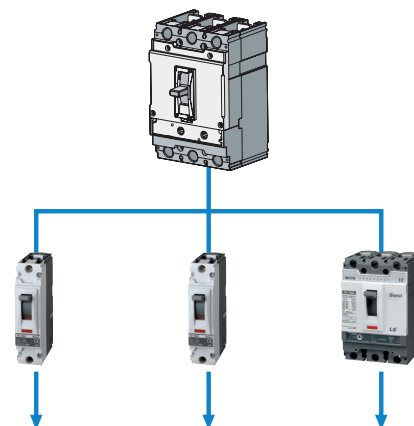

LS “Metasol series” range of MCCBs

Rated current, In	15A 100A					
Rated operational voltage, Ue	upto 415V - Single pole upto 690V - Three pole					
Breaker type	ABS103c					
	N		H		L	
No. of poles	2P	3P	2P	3P	2P	3P
Ultimate breaking capacity, Icu (kA rms) at 240V	35		85		100	
Ultimate breaking capacity, Icu (kA rms) at 415V	18		37		50	
Service breaking capacity, Ics.....% Icu	100% Icu					
Protection trip unit	Thermal magnetic					

Incoming application

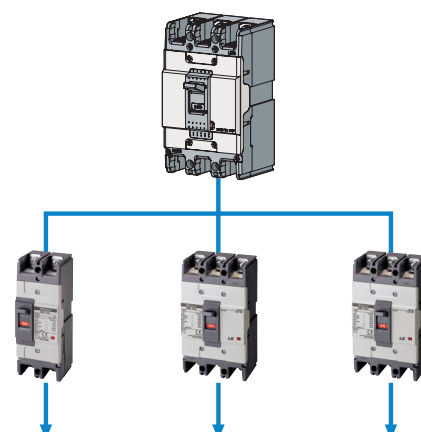

Vacuum Circuit Breakers

Susol VCB Series

VL-06

Type			VL-06□08□04	VL-06□13□08
Rated voltage	Ur (kV)		7.2	
Rated normal current	Ir (A)		400	630
Rated frequency	fr (Hz)		50/60	
Rated short-circuit current	Isc (kA)		8	12.5
Rated short-time withstand current	Ik/tk (kA/s)		8/3	12.5/3
Rated short-circuit breaking capacity	(MVA)		100	160
Rated short-circuit making current	Ip (kA)		2.5 × Isc (50Hz)/2.6 × Isc (60Hz)	
Rated short-circuit making current	(Cycle)		3	
Rated withstand voltage	Power frequency (1 min)	Ud (kV)	20	
	Impulse (1.2×50μs)	Up (kV)	60	
Rated operating sequence			O-0.3s-CO-15s-CO	
Control voltage	Closing coil	(V)	AC/DC 100~130, AC/DC 200~250, DC 125, DC 24~30, DC 48~60, AC 48	
	Trip coil	(V)	AC/DC 100~130, AC/DC 200~250, DC 125, DC 24~30, DC 48~60, AC 48	
Auxiliary contacts			2a2b, 4a4b, 6a6b	
Rated opening time			(sec) ≤ 0.04	
No-load closing time			(sec) ≤ 0.06	
Type test class	Mechanical		M2	
	Electrical		E2 (List1)	
	Capacitive current switching		C2	
Installation version	Fixed		P type	
	Drawout		E, F, G type (for MESG)	
Phase distance			(mm) 130	
Weight	Breaker (E, F, G, K type)	(kg)	37	37
	Cradle (E, F, G, K type)	(kg)	18, 25, 32	19, 26, 33
Standarde aplicate			IEC 62271-100, JEC 2300/JIS C 4603, V-check (KESCO)	

VL-06/12/17

Type			VL-06□20/25□06/13/20			VL-12□20/25□06/13/20			VL-17□20/25□06/13/20		
Rated voltage	Ur (kV)		7.2			12			17.5		
Rated normal current	Ir (A)		630	1250	2000	630	1250	2000	630	1250	2000
Rated frequency	fr (Hz)		50/60								
Rated short-circuit current	Isc (kA)		20, 25								
Rated short-time withstand current	Ik/tk (kA/s)		20/3, 25/3								
Rated short-circuit breaking capacity	(MVA)		250/310			410/520			600/750		
Rated short-circuit making current	Ip (kA)		2.5 × Isc (50Hz)/2.6 × Isc (60Hz)								
Rated short-circuit making current	(Cycle)		3								
Rated withstand voltage	Power frequency (1 min)	Ud (kV)	20			28 (42)			38		
	Impulse (1.2×50μs)	Up (kV)	60			75 (82)			95		
Rated operating sequence			O-0.3s-CO-15s-CO								
Control voltage	Closing coil	(V)	DC 24~30, DC 48~60, DC 110, DC 125, DC 220~250, AC 48, AC 100~130, AC 220~250								
	Trip coil	(V)	DC 24~30, DC 48~60, DC 110, DC 125, DC 220~250, AC 48, AC 100~130, AC 220~250								
Auxiliary contacts			4a4b, 10a10b								
Rated opening time			(sec) ≤ 0.04								
No-load closing time			(sec) ≤ 0.06								
Type test class	Mechanical		M2								
	Electrical		E2 (List3)								
	Capacitive current switching		C2								
Installation version *	Fixed		P type								
	Drawout		E, F, G type (for MESG), H type (for MCSG)			E, F type (for MESG), H type (for MCSG)					
Phase distance **			150			150 (210)			150 (210)		
Weight	Breaker (E, F, G, K type)	(kg)	100	100	130	115 (120)	115 (120)	130 (140)	115 (120)	115 (120)	130 (140)
	Cradle (E, F, G, K type)	(kg)	170	170	180	170 (200)	170 (200)	180 (200)	170 (200)	170 (200)	180 (200)
Standarde aplicate			IEC 62271-100, KERI/KEMA, V-check (KESCO)								

* H type is a box type cradle with CB compartment style structure.
 ** () displays option of phase distance.

VL-06/12/17

Type			VL-06□32□06/13/20			VL-12□32□06/13/20/25				VL-17□32□06/13/20/25			
Rated voltage	Ur (kV)		7.2			12				17.5			
Rated normal current	Ir (A)		630	1250	2000	630	1250	2000	2500	630	1250	2000	2500
Rated frequency	fr (Hz)		50/60										
Rated short-circuit current	Isc (kA)		31.5										
Rated short-time withstand current	Ik/tk (kA/s)		31.5/3(4 ^{Note 1)})										
Rated short-circuit breaking capacity	(MVA)		393			655				955			
Rated short-circuit making current	Ip (kA)		2.5×Isc (50Hz)/2.6×Isc (60Hz)										
Rated short-circuit making current	(Cycle)		3										
Rated withstand voltage	Power frequency (1 min)	Ud (kV)	20			28				38			
	Impulse (1.2×50μs)	Up (kV)	60			75				95			
Rated operating sequence			O-0.3s-CO-3min-CO										
Control voltage	Closing coil	(V)	DC 24~30, DC 48~60, DC 110, DC 125, DC 220~250, AC 48, AC 100~130, AC 220~250										
	Trip coil	(V)	DC 24~30, DC 48~60, DC 110, DC 125, DC 220~250, AC 48, AC 100~130, AC 220~250										
Auxiliary contacts			4a4b, 10a10b										
Rated opening time	(sec)		≤ 0.04										
No-load closing time	(sec)		≤ 0.06										
Type test class	Mechanical		M2										
	Electrical		E2 (List3)										
	Capacitive current switching		C2										
Installation version *	Fixed		P type										
Drawout			H type (for MCSG)	E, F, Fs, G, Gs, K type (for MESH)	H type (for MCSG)	Gs, K type (for MESH)	H type (for MCSG)	H type (for MCSG)	H type (for MCSG)				
Phase distance **	(mm)		150			150 (210)			210 (275)	150 (210)		210 (275)	
Weight	Breaker (H type)	(kg)	100	100	130	115/120	115/120	130/140	160/175	115/120	115/120	130/140	160/175
	Cradle (H, type)	(kg)	170	170	200	170/200	170/200	170/200	260/290	170/200	170/200	170/200	260/290
	Breaker (P, E, F, G, K type)	(kg)	85	85	100	85/100	85/100	100/115	120/135	85/100	85/100	100/115	120/135
Standarde aplicate			IEC 62271-100, KERI, V-check(KESCO)										

* H type is a box type cradle with CB compartment style structure. ** () displays option of phase distance.
 Nota 1) For Icw 4s, please contact us.

VL-20/25

Type			VL-20,25□13□06/13			VL-20,25□16□06/13			VL-20,25□25□06/13/20/25					
Rated voltage	Ur (kV)		7.2			12			17.5					
Rated normal current	Ir (A)		630	1250		630	1250		630	1250	2000	2500		
Rated frequency	fr (Hz)		50/60 ^{Note 1)}											
Rated short-circuit current	Isc (kA)		12.5			16			25					
Rated short-time withstand current	Ik/tk (kA/s)		12.5/3 ^{Note 2)}			16/3 ^{Note 2)}			25/3 ^{Note 2)}					
Rated short-circuit breaking capacity	(MVA)		520/560			665/715			1040/1120					
Rated short-circuit making current	Ip (kA)		2.5×Isc (50Hz)/2.6×Isc (60Hz)											
Rated short-circuit making current	(Cycle)		3											
Rated withstand voltage	Power frequency (1 min)	Ud (kV)	50/60											
	Impulse (1.2×50μs)	Up (kV)	125											
Rated operating sequence			O-0.3s-CO-3min-CO											
Control voltage	Closing coil	(V)	DC 24~30, DC 48~60, DC 110, DC 125, DC 220~250, AC 48, AC 100~130, AC 220~250											
	Trip coil	(V)	DC 24~30, DC 48~60, DC 110, DC 125, DC 220~250, AC 48, AC 100~130, AC 220~250											
Auxiliary contacts			4a4b, 10a10b											
Rated opening time	(sec)		≤ 0.04											
No-load closing time	(sec)		≤ 0.06											
Type test class	Mechanical		M2											
	Electrical		E2 (List3)											
	Capacitive current switching		C2											
Installation version *	Fixed		P type											
Drawout			E, F, G type (for MESH), K, H type (for MCSG)										H type (for MCSG)	
Phase distance **	(mm)		210/265/275						275					
Weight	Breaker (H type)	(kg)	120 (130)			130 (140)			150 (160)					
	Cradle (H, type)	(kg)	200 (220)			200 (220)			200 (220)					
	Breaker (P, E, F, G, K type)	(kg)	110	115		120			135	-				
Standarde aplicate			IEC 62271-100, KERI, V-check(KESCO)											

* H type is a box type cradle with CB compartment style structure. ** () displays option of phase distance.
 Nota 1) 24/25.8kV 25kA 2000A(Phase distance 210mm): 60Hz available only 2) For Icw 4s, please contact us.

Vacuum Circuit Breakers

Susol VCB Series

VL-36

Type			VH-36□25□06	VH-36□25□13	VH-36□25□20	VH-36□25□25
Rated voltage	Ur (kV)		36			
Rated normal current	Ir (A)		630	1250	2000	2500
Rated frequency	fr (Hz)		50/60			
Rated short-circuit current	Isc (kA)		60			
Rated short-time withstand current	Ik/tk (kA/s)		25/3(4 ^{Note 1)})			
Rated short-circuit breaking capacity	(MVA)		1560			
Rated short-circuit making current	Ip (kA)		62.5/65			
Rated short-circuit making current	(Cycle)		3			
Rated withstand voltage	Power frequency (1 min)	Ud (kV)	70			
	Impulse (1.2 × 50μs)	Up (kV)	170			
Rated operating sequence			O-0.3s-CO-15s-CO			
Control voltage	Closing coil	(V)	DC 24~30, DC 48~60, DC 110, DC 125, DC 220, AC 48, AC 100~130, AC 220~250			
	Trip coil	(V)	DC 24~30, DC 48~60, DC 110, DC 125, DC 220, AC 48, AC 100~130, AC 220~250			
Auxiliary contacts			4a4b, 10a10b			
Rated opening time	(sec)		≤ 0.04			
No-load closing time	(sec)		≤ 0.07			
Type test class	Mechanical		M2			
	Electrical		E2 (List3)			
	Capacitive current switching		C2			
Installation version	Fixed		P type			
	Drawout		H type (for MCSG)			
Phase distance	(mm)		275			
Weight	Breaker (H type)	(kg)	260	260	280	300
	Cradle (H, type)	(kg)	440	440	450	460
Standards			IEC 62271-100			

Note 1) For Icw 4s, please contact us.

LVB-06/12

Type			VH-06□32□32		VH-06□40□12, 20, 32			VH-12□32□32		VH-12□40□12, 20, 32		
Rated voltage	Ur (kV)		7.2		7.2			12		12		
Rated normal current	Ir (A)		3150 *		1250	2000	3150 *	3150 *		1250	2000	3150 *
Rated frequency	fr (Hz)		50/60									
Rated short-circuit current	Isc (kA)		31.5		40			31.5		40		
Rated short-time withstand current	Ik/tk (kA/s)		31.5/3		40/3			31.5/3		40/3		
Rated short-circuit breaking capacity	(MVA)		393		499			655		831		
Rated short-circuit making current	Ip (kA)		2.5 × Isc (50Hz)/2.6 × Isc (60Hz)									
Rated short-circuit making current	(Cycle)		3									
Rated withstand voltage	Power frequency (1 min)	Ud (kV)	20					28				
	Impulse (1.2 × 50μs)	Up (kV)	60					75				
Rated operating sequence			O-0.3s-CO-3min-CO									
Control voltage	Closing coil	(V)	DC 48, DC 110, DC 125, DC 220~250, AC 48, AC 110, AC 220									
	Trip coil	(V)	DC 48, DC 110, DC 125, DC 220~250, AC 48, AC 110, AC 220									
Auxiliary contacts			4a4b, 10a10b									
Rated opening time	(sec)		≤ 0.04									
No-load closing time	(sec)		≤ 0.06									
Type test class	Mechanical		M2									
	Electrical		E2 (List1)									
	Capacitive current switching		C2									
Installation version *	Fixed		P type									
	Drawout		E,F,G type (for MESH), MCSG Cradle			MCSG Cradle						
Phase distance	(mm)	210	150	210	210	150	210	150	210	150	210	
Weight	Breaker (MESH, MCSG type)	(kg)	210, 220	135, 160	135, 160	210, 220	220	164	165	220		
	Cradle (MESH, MCSG type)	(kg)	135, 155	55, 110	63, 117	135, 155	155	110	117	155		
Standards			IEC 62271-100, KERI/KEMA, V-check(KESCO)									

* MCSG style drawable type provides a cradle for building in the switchgear, not a box type for CB compartment. Ordering type is LVB.

Note 1) H type that is a box type cradle for enabling a CB compartment in MCSG is under development. Consult us for ordering.

2) Some LVB is the ordering name of the switchboard for export

VH-06/12/17

Type			VH-06/12□40□13/20				VH-06/12/17□40□13/20					
Rated voltage	Ur (kV)		7.2		12		7.2		12		17.5	
Rated normal current	Ir (A)		1250	2000	1250	2000	1250	2000	1250	2000	1250	2000
Rated frequency	fr (Hz)		50/60									
Rated short-circuit current	Isc (kA)		40									
Rated short-time withstand current	Ik/tk (kA/s)		40/4									
Rated short-circuit breaking capacity	(MVA)		499		831		499		831		1212	
Rated short-circuit making current	Ip (kA)		2.5 × Isc (50Hz)/2.6 × Isc (60Hz)									
Rated short-circuit making current	(Cycle)		3									
Rated withstand voltage	Power frequency (1 min)	Ud (kV)	20		28 (42)		20		28 (42)		38	
	Impulse (1.2 × 50μs)	Up (kV)	60		75		60		75		95	
Rated operating sequence			O-0.3s-CO-3min-CO					O-0.3s-CO-15s-CO				
Control voltage	Closing coil	(V)	DC 48, DC 110, DC 125, DC 220~250, AC 48, AC 110, AC 220									
	Trip coil	(V)	DC 48, DC 110, DC 125, DC 220~250, AC 48, AC 110, AC 220									
Auxiliary contacts			4a4b, 10a10b									
Rated opening time		(sec)	≤ 0.04									
No-load closing time		(sec)	≤ 0.06									
Type test class	Mechanical		M2									
	Electrical		E2 (List3)									
	Capacitive current switching		C2									
Installation version	Drawout		Fs, Gs, K, H type					K, H type				
Phase distance		(mm)	150					210				
Weight	Breaker (H type)	(kg)	165					215				
	Cradle (H, type)	(kg)	205					226				
Standards			IEC 62271-100									

VH-06/12/17

Type			VH-06/12/17□32/40□32						
Rated voltage	Ur (kV)		7.2		12		17.5		
Rated normal current	Ir (A)		3150						
Rated frequency	fr (Hz)		50/60						
Rated short-circuit current	Isc (kA)		31.5/40						
Rated short-time withstand current	Ik/tk (kA/s)		40/4						
Rated short-circuit breaking capacity	(MVA)		393/499		655/831		955/1212		
Rated short-circuit making current	Ip (kA)		2.5 × Isc (50Hz)/2.6 × Isc (60Hz)						
Rated short-circuit making current	(Cycle)		3						
Rated withstand voltage	Power frequency (1 min)	Ud (kV)	20		28 (42)		38		
	Impulse (1.2 × 50μs)	Up (kV)	60		75		95		
Rated operating sequence			O-0.3s-CO-15s-CO						
Control voltage	Closing coil	(V)	DC 48, DC 110, DC 125, DC 220~250, AC 48, AC 110, AC 220						
	Trip coil	(V)	DC 48, DC 110, DC 125, DC 220~250, AC 48, AC 110, AC 220						
Auxiliary contacts			4a4b, 10a10b						
Rated opening time		(sec)	≤ 0.04						
No-load closing time		(sec)	≤ 0.06						
Type test class	Mechanical		M2						
	Electrical		E2 (List3)						
	Capacitive current switching		C2						
Installation version	Drawout		Fs, Gs, K, H type		Gs, K, H type		K, H type	K type	H type
Phase distance		(mm)	210		210		210	254	275
Weight	Breaker (H type)	(kg)	240		240		240	280	280
	Cradle (H, type)	(kg)	235		235		235	250	250
Standards			IEC 62271-100						

Vacuum Circuit Breakers

Susol VCB Series

VH-06/12/17

Type			VH-06□50□13/20/25/32				VH-12□50□13/20/25/32				VH-17□50□13/20/25/32			
Rated voltage	Ur (kV)		7.2				12				17.5			
Rated normal current	Ir (A)		1250	2000	2500	3150	1250	2000	2500	3150	1250	2000	2500	3150
Rated frequency	fr (Hz)		60											
Rated short-circuit current	Isc (kA)		50											
Rated short-time withstand current	Ik/tk (kA/s)		50/3											
Rated short-circuit breaking capacity	(MVA)		623				1039				1515			
Rated short-circuit making current	Ip (kA)		2.6 × Isc (60Hz)											
Rated short-circuit making current	(Cycle)		3											
Rated withstand voltage	Power frequency (1 min)	Ud (kV)	20				28 (42) <small>Note)</small>				38			
	Impulse (1.2×50μs)	Up (kV)	60				75				95			
Rated operating sequence			O-0.3s-CO-3min-CO											
Control voltage	Closing coil	(V)	DC 48, DC 110, DC 125, DC 220-250, AC 48, AC 110, AC 220											
	Trip coil	(V)	DC 48, DC 110, DC 125, DC 220-250, AC 48, AC 110, AC 220											
Auxiliary contacts			4a4b, 10a10b											
Rated opening time	(sec)		≤ 0.04											
No-load closing time	(sec)		≤ 0.06											
Type test class	Mechanical		M2											
	Electrical		E2 (List3)											
	Capacitive current switching		C2											
Installation version	Fixed		P type											
	Drawout		H type (for MCSG)											
Phase distance	(mm)		210	275		210	275		210	275				
Weight	Breaker (H type)	(kg)	230	287	290	230	287	290	230	287	290			
	Cradle (H, type)	(kg)	175	320	320	175	320	320	175	320	320			
Standarde aplicate			IEC 62271-100, KERI/KEMA, V-check(KESCO)											

* H type is a box type cradle with CB compartment style structure.
 Note) Contact us.

VH-06/12/17

Type			VH-06/12/17□40□40			VH-06/12/17□50□40		
Rated voltage	Ur (kV)		7.2	12	17.5	7.2	12	17.5
Rated normal current	Ir (A)		4000					
Rated frequency	fr (Hz)		50/60					
Rated short-circuit current	Isc (kA)		40			50		
Rated short-time withstand current	Ik/tk (kA/s)		40/4			50/4		
Rated short-circuit breaking capacity	(MVA)		499	831	1212	624	1040	1515
Rated short-circuit making current	Ip (kA)		104			130		
Rated short-circuit making current	(Cycle)		3					
Rated withstand voltage	Power frequency (1 min)	Ud (kV)	20	28 (42)	38	20	28 (42)	38
	Impulse (1.2 × 50μs)	Up (kV)	60	75	95	60	75	95
Rated operating sequence			O-0.3s-CO-15s-CO					
Control voltage	Closing coil	(V)	DC 48, DC 110, DC 125, DC 220-250, AC 48, AC 110, AC 220					
	Trip coil	(V)	DC 48, DC 110, DC 125, DC 220-250, AC 48, AC 110, AC 220					
Auxiliary contacts			4a4b, 10a10b					
Rated opening time	(sec)		≤ 0.04					
No-load closing time	(sec)		≤ 0.06					
Type test class	Mechanical		M2					
	Electrical		E2 (List3)					
	Capacitive current switching		C2					
Installation version	Fixed		-	-	P type	-	-	P type
	Drawout		H type	H type	H type	H type	H type	H type
Phase distance	(mm)		275					
Weight	Breaker (H type)	(kg)	395					
	Cradle (H, type)	(kg)	200					
Standarde aplicate			IEC 62271-100					

VH-06/12

Type			VH-06H40,50L50	VH-12H40,50L50
Rated voltage	Ur (kV)		7.2	12
Rated normal current	Ir (A)		5000	5000
Rated frequency	fr (Hz)		50/60	
Rated short-circuit current	Isc (kA)		40/50	
Rated short-time withstand current	Ik/tk (kA/s)		50/4	
Rated short-circuit breaking capacity	(MVA)		624	1040
Rated short-circuit making current	Ip (kA)		2.5 × Isc (50Hz)/2.6 × Isc (60Hz)	
Rated short-circuit making current	(Cycle)		3	
Rated withstand voltage	Power frequency (1 min)	Ud (kV)	20	20
	Impulse (1.2 × 50μs)	Up (kV)	60	75
Rated operating sequence			O-0.3s-CO-15s-CO	
Control voltage	Closing coil	(V)	DC 48, DC 110, DC 125, DC 220~250, AC 48, AC 110, AC 220	
	Trip coil	(V)	DC 48, DC 110, DC 125, DC 220~250, AC 48, AC 110, AC 220	
Auxiliary contacts			4a4b, 10a10b	
Rated opening time			(sec) ≤ 0.04	
No-load closing time			(sec) ≤ 0.06	
Type test class	Mechanical		M2	
	Electrical		E2 (List3)	
	Capacitive current switching		C2	
Installation version	Fixed		P type	
	Drawout		H type (for MCSG)	
Phase distance		(mm)	320	
Weight	Breaker (H type)		(kg) 430	
	Cradle (H, type)		(kg) 200	
Standards			IEC 62271-100	

VH-20/25

Type			VH-20,25□25□25		VH-20,25□32□13/20/32			VH-20,25□40□13/20/32		
Rated voltage	Ur (kV)		24/25.8							
Rated normal current	Ir (A)		2500	1250	2000	3150	1250	2000	3150	
Rated frequency	fr (Hz)		50/60		60			50/60		
Rated short-circuit current	Isc (kA)		25		31.5			40		
Rated short-time withstand current	Ik/tk (kA/s)		25/3		31.5/3			40/3		
Rated short-circuit breaking capacity	(MVA)		1039/1117		1309/1407			1662/1787		
Rated short-circuit making current	Ip (kA)		2.6 × Isc (60Hz)							
Rated short-circuit making current	(Cycle)		3							
Rated withstand voltage	Power frequency (1 min)	Ud (kV)	50 (65) ^{Note)}							
	Impulse (1.2×50μs)	Up (kV)	125							
Rated operating sequence			O-0.3s-CO-3min-CO							
Control voltage	Closing coil	(V)	DC 48, DC 110, DC 125, DC 220~250, AC 48, AC 110, AC 220							
	Trip coil	(V)	DC 48, DC 110, DC 125, DC 220~250, AC 48, AC 110, AC 220							
Auxiliary contacts			4a4b, 10a10b							
Rated opening time			(sec) ≤ 0.04							
No-load closing time			(sec) ≤ 0.06							
Type test class	Mechanical		M2							
	Electrical		E2 (List3)							
	Capacitive current switching		C2							
Installation version	Fixed		P type							
	Drawout		H type (for MCSG)							
Phase distance		(mm)	275	210 (275)	210 (275)	275	210 (275)	210 (275)	275	
Weight	Breaker (H type)		(kg) 295	256 (273)	256 (273)	318	256 (273)	256 (273)	318	
	Cradle (H, type)		(kg) 316	257 (284)	257 (284)	316	257 (284)	257 (284)	316	
Standarde aplicate			IEC 62271-100, KERI/KEMA, V-check(KESCO)							

* H type is a box type cradle with CB compartment style structure. ** () displays option of phase distance. *** Rated frequency(fr) 50Hz is certified only to 24kV.

**** Rated operating sequence O-0.3s-CO-15s-CO is certified only to 24kV 40kA.

Note) Contact us.

Vacuum Circuit Breakers



Susol VCB Series

VH-36

Type		VH-36□25□13/20/32			VH-36□32□13/20/32			VH-36□40□13/20/32		
Rated voltage	Ur (kV)	36								
Rated normal current	Ir (A)	1250	2000	3150	1250	2000	3150	1250	2000	3150
Rated frequency	fr (Hz)	50/60								
Rated short-circuit current	Isc (kA)	25			31.5			40		
Rated short-time withstand current	Ik/tk (kA/s)	25/3			31.5/3			40/3		
Rated short-circuit breaking capacity	(MVA)	1559			1964			2494		
Rated short-circuit making current	I _p (kA)	2.5 × I _{sc} (50Hz)/2.6 × I _{sc} (60Hz)								
Rated short-circuit making current	(Cycle)	3								
Rated withstand voltage	Power frequency (1 min)	70 (95) <i>Note</i>								
	Impulse (1.2×50μs)	170								
Rated operating sequence		O-0.3s-CO-3min-CO								
Control voltage	Closing coil	DC 48, DC 110, DC 125, DC 220-250, AC 48, AC 110, AC 220								
	Trip coil	DC 48, DC 110, DC 125, DC 220-250, AC 48, AC 110, AC 220								
Auxiliary contacts		4a4b, 10a10b								
Rated opening time	(sec)	≤ 0.04								
No-load closing time	(sec)	≤ 0.06								
Type test class	Mechanical	M2								
	Electrical	E2 (List3)								
	Capacitive current switching	C2								
Installation version *	Fixed	P type								
	Drawout	H type (for MCSG)								
Phase distance	(mm)	300								
Weight	Breaker (E, F, G, K type)	400	490		400	490		400	490	
	Cradle (E, F, G, K type)	700	750		700	750		700	750	
Standarde aplicate		IEC 62271-100, KERI/KEMA, V-check (KESCO)								

* H type is a box type cradle with CB compartment style structure.
Note) Contact us.

Accessories

Breakers	Main	Cradle
	<ul style="list-style-type: none"> • Secondary trip coil • Under voltage trip release • Current trip coil • Position S/W • Keylock • Button padlock • Button cover • Mechanical position indicator 	<ul style="list-style-type: none"> • Mechanical position indicator
	<ul style="list-style-type: none"> • Secondary trip coil • Under voltage trip release • Current trip coil • Position S/W • Keylock • Button padlock • Button cover • Plug interlock • Mechanical position indicator 	<ul style="list-style-type: none"> • Earthing S/W • Earthing with electromechanical interlock • Earthing S/W with position S/W • Earthing S/W with keylock • Door interlock • MOC • TOC • Shutter padlock • Emergency mechanical trip device
	<ul style="list-style-type: none"> • Secondary trip coil • Under voltage trip release • Current trip coil • Position S/W • Keylock • Button padlock • Button cover • Plug interlock • Mechanical position indicator 	<ul style="list-style-type: none"> • Earthing S/W • Earthing with electromechanical interlock • Earthing S/W with position S/W • Earthing S/W with keylock • Door interlock • MOC • TOC • Shutter padlock • Emergency mechanical trip device

Various type of Cradle

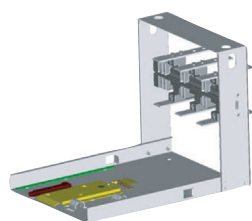

E type

- No Shutter
- For MESG

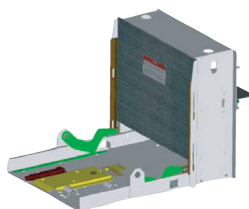

F type

- Insulation Shutter
- For MESG

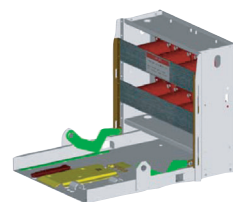

G type

- Bushing
- Insulation Shutter
- For MESG

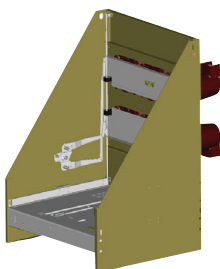

K type

- Bushing
- Closed Compartment structure
- For MCSG



H type

- Bushing
- Metal Insulation Shutter
- Closed Compartment structure
- Earthing Switch & Interlock
- For MCSG
- Door Interlock



Safety Instructions

- For your safety, please read user's manual thoroughly before operating.
- Contact the nearest authorized service facility for examination, repair, or adjustment.
- Please contact qualified service technician when you need maintenance. Do not disassemble or repair by yourself!
- Any maintenance and inspection shall be performed by the personnel having expertise concerned.



- According to The WEEE Directive, please do not discard the device with your household waste.



www.ls-electric.com

■ **Headquarter**

127 LS-ro (Hogye-dong) Dongan-gu, Anyang-si, Gyeonggi-Do, 14119, Korea

■ **Seoul Office**

LS Yongsan Tower, 92, Hangang-daero, Yongsan-gu, Seoul, 04386, Korea
Tel. 82-2-2034-4916, 4684, 4429

■ **Overseas Subsidiaries**

- **LS ELECTRIC Middle East FZE (Dubai, UAE)**
Tel: 971-4-886-5360 E-Mail: middleeast@ls-electric.com
- **LS ELECTRIC America Inc. (Lincolnshire, Illinois, USA)**
Tel: 1-224-352-2265 E-Mail: sales.us@lselectricamerica.com
- **MCM Engineering II (Enoch, Utah, USA)**
Tel: 1-435-865-0125 E-Mail: sales.us@lselectricamerica.com
- **LS ELECTRIC Energy Solution LLC. (Charlotte, North Carolina, USA)**
Tel: 1-980-221-0654 E-Mail: cmfeldman@ls-es.com
- **LS ELECTRIC Europe B.V. (Hoofddorp, Netherlands)**
Tel: 31-20-654-1424 E-Mail: europartner@ls-electric.com
- **LS ELEKTRİK SANAYİ TİCARET LİMİTED ŞİRKETİ (Istanbul, Türkiye)**
Tel: 90-212-806-1252 E-Mail: turkiye@ls-electric.com
- **LS ELECTRIC IBERIA S.L.U. (Madrid, Spain)**
Tel: 34-910-28-02-74 E-Mail: iberia@ls-electric.com
- **LS ELECTRIC(Dalian) Co., Ltd. (Dalian, China)**
Tel: 86-411-8730-7560 E-Mail: china.dalian@lselectric.com
- **LS ELECTRIC(Wuxi) Co., Ltd. (Wuxi, China)**
Tel: 86-510-8534-6666 E-Mail: china.wuxi@lselectric.com
- **LS ELECTRIC(lishui) Co., Ltd. (lishui, China)**
Tel: 86-133-6207-7980 E-Mail: china.lishui@lselectric.com.cn
- **LS ELECTRIC Japan Co., Ltd. (Tokyo, Japan)**
Tel: 81-3-6268-8241 E-Mail: japan@ls-electric.com
- **LS ELECTRIC Vietnam Co., Ltd. (Bac Ninh Province, Vietnam)**
Tel: 84-222-2221-110 E-Mail: vietnam@ls-electric.com
- **PT. LS ELECTRIC INDONESIA (Jakarta Barat, Indonesia)**
Tel: 62-2933-7614 E-Mail: indonesia@ls-electric.com

■ **Overseas Branches**

- **LS ELECTRIC America Western Office (Santa Fe Springs, California, USA)**
Tel: 1-949-333-3140 E-Mail: america@ls-electric.com
- **LS ELECTRIC America Bastrop Campus (Bastrop, TX, USA)**
Tel: 1-224-352-2265 E-Mail: sales.us@lselectricamerica.com
- **LS ELECTRIC Moscow Office (Moscow, Russia)**
Tel: 7-499-682-6130 E-Mail: info@lselectric-ru.com
- **LS ELECTRIC Italy Office (Brescia, Italia)**
Tel: 39-030-8081-833 E-Mail: italia@ls-electric.com
- **LS ELECTRIC Shanghai Office (Shanghai, China)**
Tel: 86-21-5237-9977 E-Mail: china@lselectric.com.cn
- **LS ELECTRIC Beijing Office (Beijing, China)**
Tel: 86-10-5095-1631 E-Mail: china@lselectric.com.cn
- **LS ELECTRIC Guangzhou Office (Guangzhou, China)**
Tel: 86-20-3818-2883 E-Mail: china@lselectric.com.cn
- **LS ELECTRIC Qingdao Office (Qingdao, China)**
Tel: 86-532-8501-2065 E-Mail: china@lselectric.com.cn
- **LS ELECTRIC Chengdu Office (Chengdu, China)**
Tel: 86-28-8670-3201 E-Mail: china@lselectric.com.cn
- **LS ELECTRIC Nanjing Office (Nanjing, China)**
Tel: 86-25-8467-0005 E-Mail: china@lselectric.com.cn
- **LS ELECTRIC Tokyo Office (Tokyo, Japan)**
Tel: 81-3-6268-8241 E-Mail: tokyo@ls-electric.com
- **LS ELECTRIC Bangkok Office (Bangkok, Thailand)**
Tel: 66-2-128-0295 E-Mail: thailand@ls-electric.com
- **LS ELECTRIC Co., Ltd. India Office (Karnataka, India)**
Tel: 91-80-6142-9108 E-Mail: info_india@ls-electric.com
- **LS ELECTRIC Co., Ltd. Singapore Branch (Singapore)**
Tel: 65-6958-8162 E-Mail: singapore@ls-electric.com